

soltec  
More life.



LIFTING

FOLDING

SLIDING

**SHUTTERS**



soltec  
More Life.

**SHUTTERS**  
LIFTING | FOLDING | SLIDING

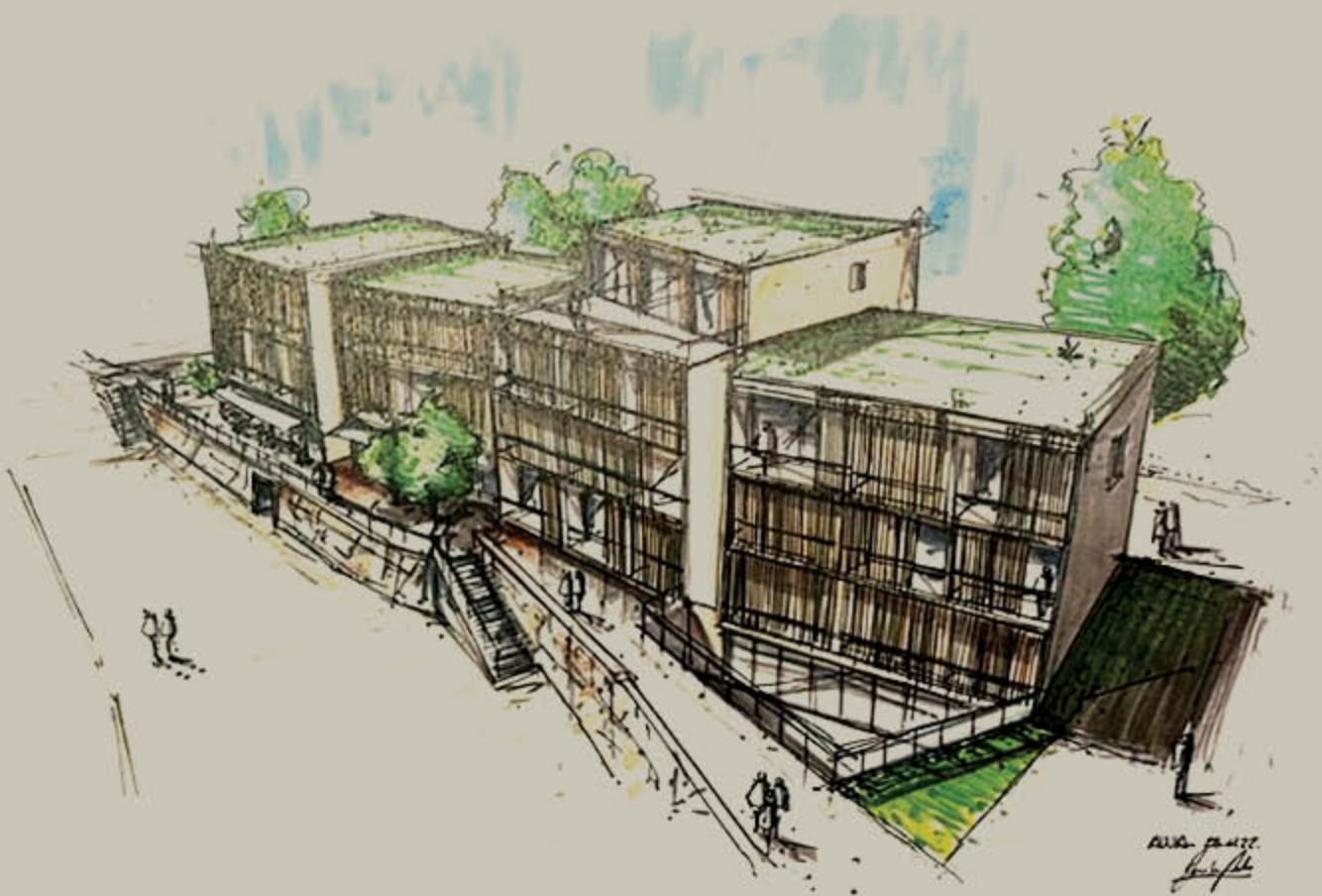

Atelier West  
Architekten

Shading solutions are becoming an increasingly important part of modern architecture that serves people by combining functionality, aesthetics, and living comfort with sustainability.

**Soltec architectural shading solutions help architects, builders, and investors achieve their dreams by offering various materials, colours, shapes, and accessories.**

**INTRODUCTION**



Atelier West  
Architekten

Modern multifunctional facade elements offer:

#### UNIQUE DESIGN

Custom-made facade systems and shutters allow architects to design projects that bring them recognition, and offer clients a unique architectural experience.

#### ENERGY EFFICIENCY

Only top-quality facade systems and customized shading solutions can help reduce energy consumption and lower the building's carbon footprint.

#### MORE FUNCTIONALITY

Thoughtfully designed shutters that blend into the facade perform multiple functions: shading, maintaining privacy, and providing security.

INTRODUCTION



## 11 LIFTING SHUTTERS

The shutters can be raised and lowered by an electromotive drive. During the summer, when the sun is high and strong, the shutters can be lifted to create an eave that provides shading to the space while allowing a completely open view. The shutters can be lowered when the sun is low to achieve the desired shading effect.

Due to their unique mechanism, the shutters cannot be manually lifted, offering extremely high security.

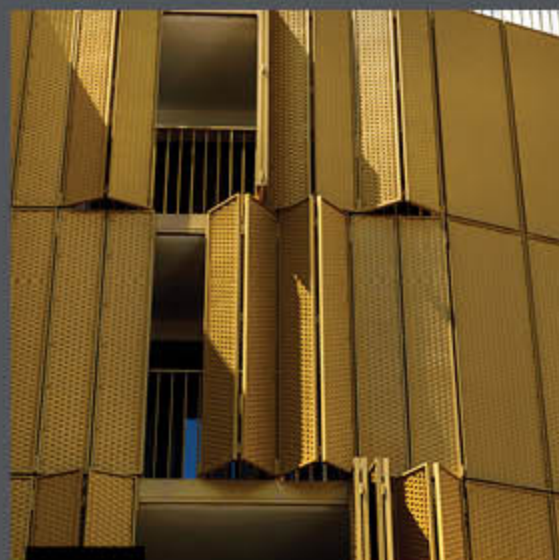

## 26 FOLDING SHUTTERS

Folding shutters can be opened manually in both directions - left or right, following the principle of an accordion. The individual panels in the shutter fold next to each other when opened, taking up very little space. On the other hand, closed shutters blend in with the facade and create a unified look of the building.

These blinds allow for adjusting their position, ensuring appropriate shading and privacy for interior spaces.





## 45 SLIDING SHUTTERS

Sliding shutters consist of panels that can be manually moved to the left or right, thus revealing or covering windows. When opened, the blinds are moved away from the glass surfaces, providing an unobstructed view through the windows.

The shutters can be moved to any position, allowing control over the amount of sunlight that enters the room and creating as much privacy as desired at any given time.



## 71 FRAMES, PANELS & ACCESSORIES

## 96 CONTACT

INDEX

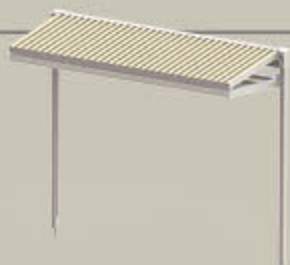

**LIFTING SHUTTERS | TYPE LPS 60**

Side guidance



**LIFTING SHUTTERS | TYPE LPF 60**

Front guidance



**LIFTING SHUTTERS | TYPE LPF 60R**

Front guidance with balcony railing



**LIFTING SHUTTERS | TYPE LPS 80**

Side guidance XL



**LIFTING SHUTTERS | TYPE LPF 220**

Front guidance XXL

# LIFTING SHUTTERS

Lifting mechanisms are designed for supporting any chosen infills made by Soltec.



# LIFTING SHUTTERS

**TYPE LPS 60** / side guidance / guide 60  
**LPF 60** / front guidance / guide 60  
**LPF 60R** / front guidance / guide 60 / with railing

These motorized lifting shutters are made of aluminium guides with dimensions of 60 x 60 mm, in which a unique sliding mechanism with a toothed belt drive is installed.

The shutter frame is made of ALU L-profiles with 50 x 50 mm dimensions. Both frames are attached to guides, one side is rotatable, and the other is lifting.

The filling of the panels can be made of different materials such as wood, glass, expanded metal sheets, perforated metal sheets and ALU profiles.

The shutters can be fully aligned with the facade when in the lowered position.

Designed  
for **window**  
**surfaces** up to

**4** m<sup>2</sup>

Infill up to **30 kg/m<sup>2</sup>**

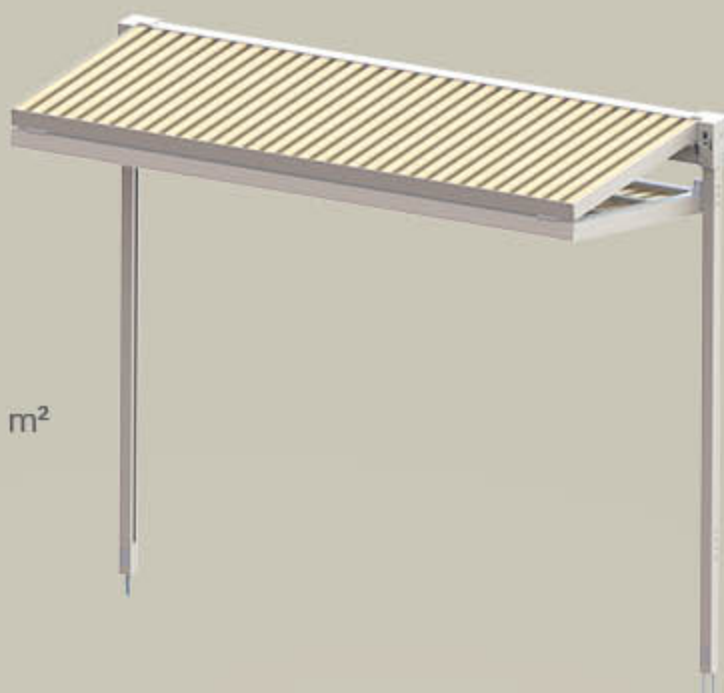

# LIFTING SHUTTERS

TYPE LPS 60

SIDE GUIDED MOTORIZED LIFTING SHUTTERS

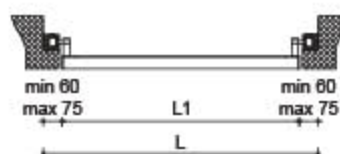
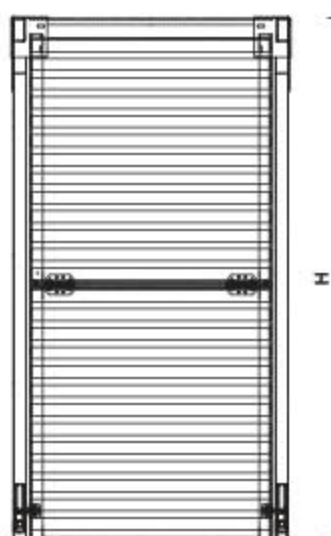
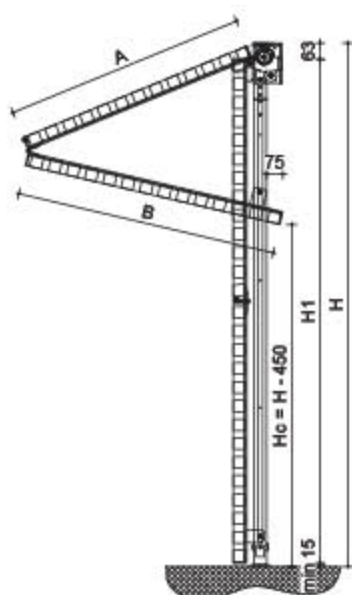

# LIFTING SHUTTERS

FRONT GUIDED MOTORIZED LIFTING SHUTTERS

TYPE LPF 60

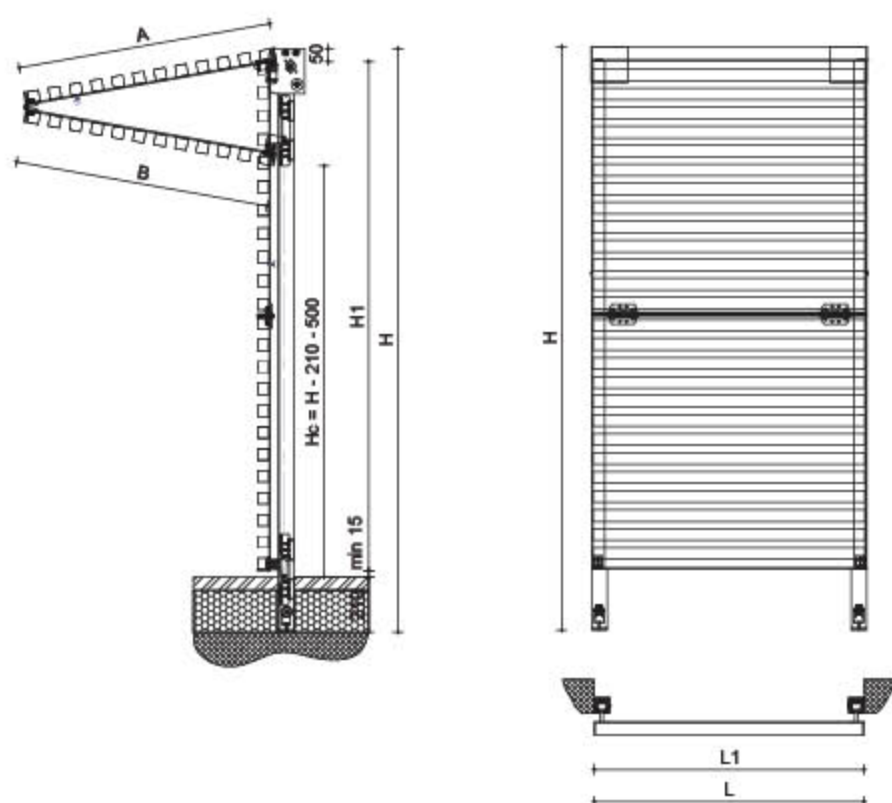

# LIFTING SHUTTERS

TYPE LPF 60R

FRONT GUIDED MOTORIZED LIFTING SHUTTERS WITH INTEGRATED RAILING

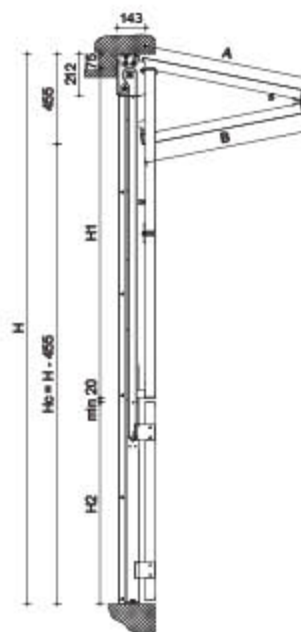
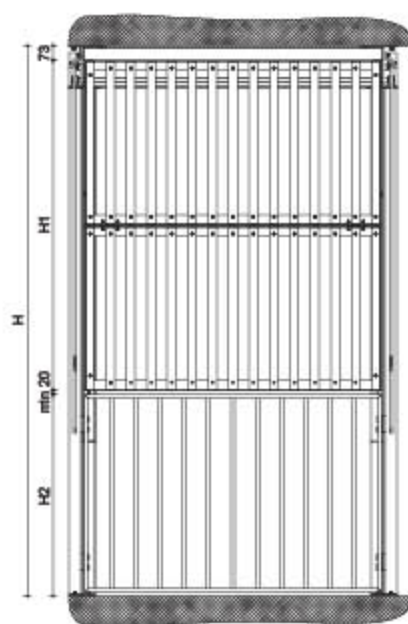
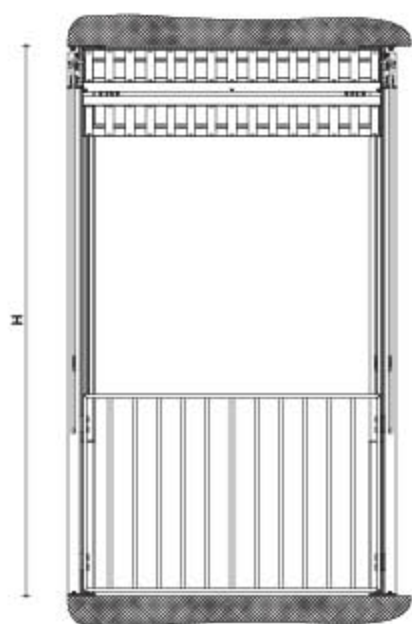







# LIFTING SHUTTERS **XL**

TYPE LPS 80

These motorized lifting shutters are made of aluminium guides with dimensions of 90 x 90 mm, in which a unique sliding mechanism with a toothed belt drive is installed.

The panel frame is made of ALU L-profiles with dimensions of 80 x 80 mm. Both frames are attached to guides, one side is rotatable, and the other is lifting.

The infill of the panels can be made of different materials such as wood, glass, expanded metal sheets, perforated metal sheets and ALU profiles.

The shutters can be fully aligned with the facade when in the lowered position.

When using this type of shutter as a door, it is necessary to add safety photocells sensors that prevent the shutter from slipping onto an obstacle.



Designed for **window surfaces** up to **9** m<sup>2</sup>

Infill up to **30 kg/m<sup>2</sup>**



# LIFTING SHUTTERS XL

FRONT GUIDED MOTORIZED LIFTING SHUTTERS  
FOR BIGGER OPENINGS UP TO 9m<sup>2</sup>

TYPE LPS 80

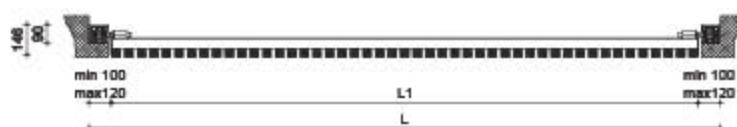
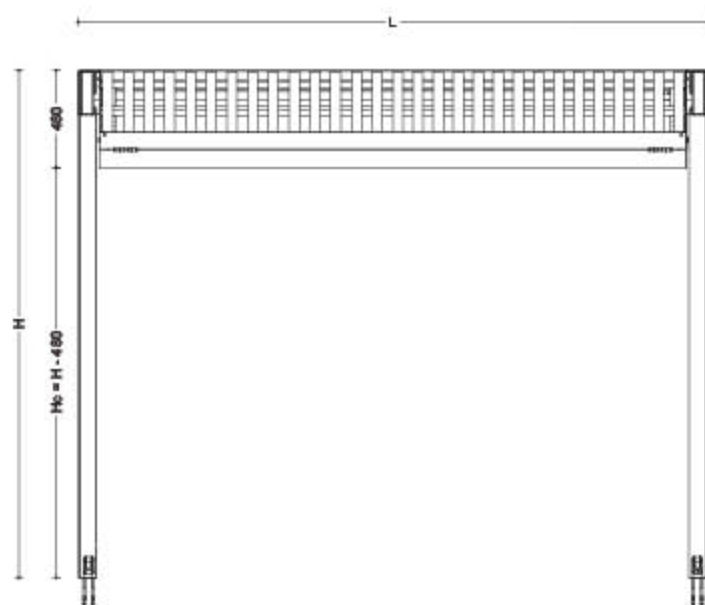
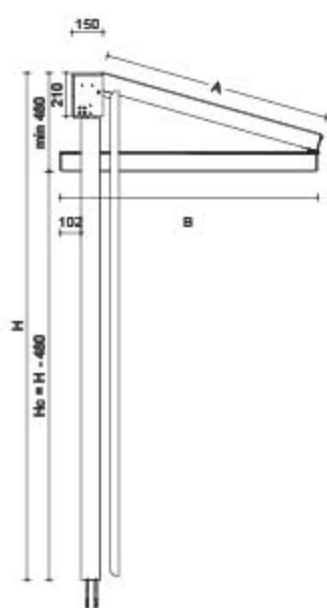



# LIFTING SHUTTERS **XXL**

**TYPE LPF 220**

These are not just shading solutions but extensive facade motorized lifting shutters that can cover an area of up to 25 m<sup>2</sup> and therefore serve as a door or an entire wall.

Due to their size, they have a steel supporting structure, and their lifting mechanism is made of a motorized screw jack.

The panels can be filled with various materials. The most commonly used ones are wood, expanded metal sheets, and glass.

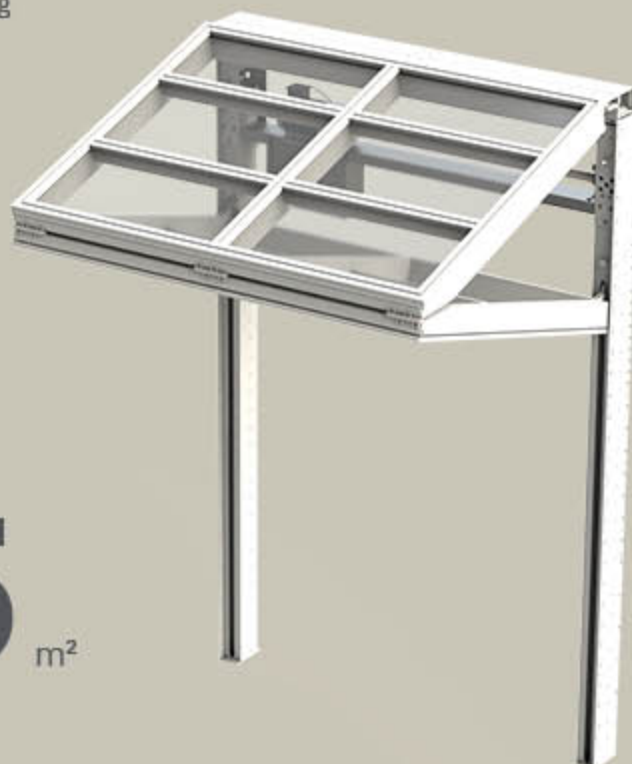

Designed for  
**door or wall**  
**surfaces** up to

**25** m<sup>2</sup>

Infill up to **130 kg/m<sup>2</sup>**





# LIFTING SHUTTERS **XXL**

FRONT GUIDED MOTORIZED LIFTING SHUTTERS  
FOR BIGGEST OPENINGS UP TO 25m<sup>2</sup>

**TYPE LPF 220** |

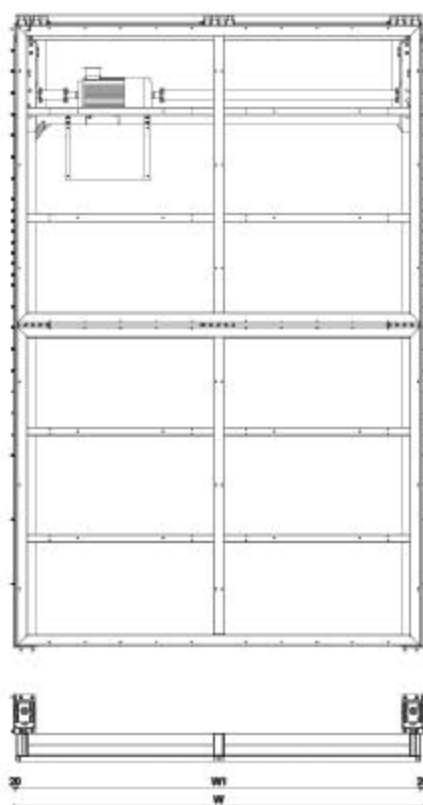
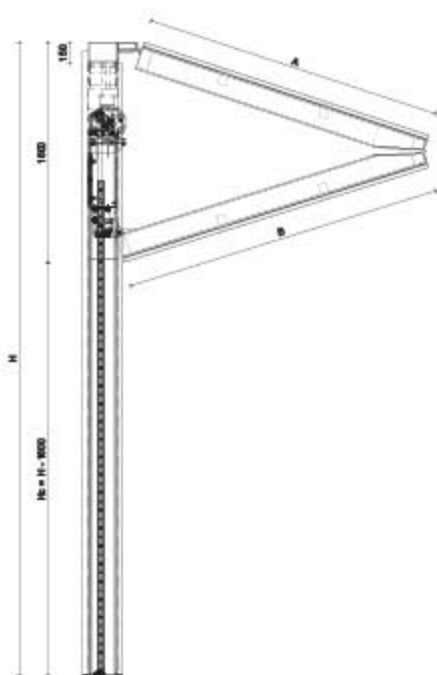

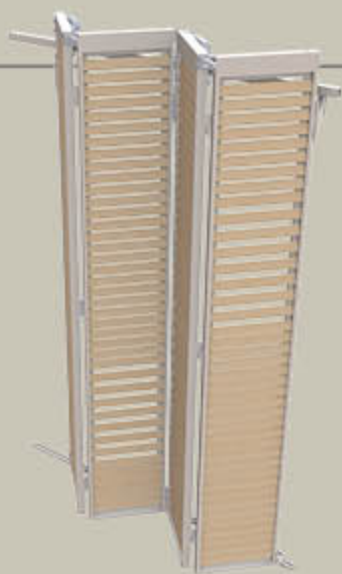

**FOLDING SHUTTERS | TYPE FPE**

Shutters with extended alignment  
with guides



**FOLDING SHUTTERS | TYPE FPC**

Shutters with centered alignment  
with guides

# FOLDING SHUTTERS

Folding mechanisms can be used up to 6 panels, with various infill options.

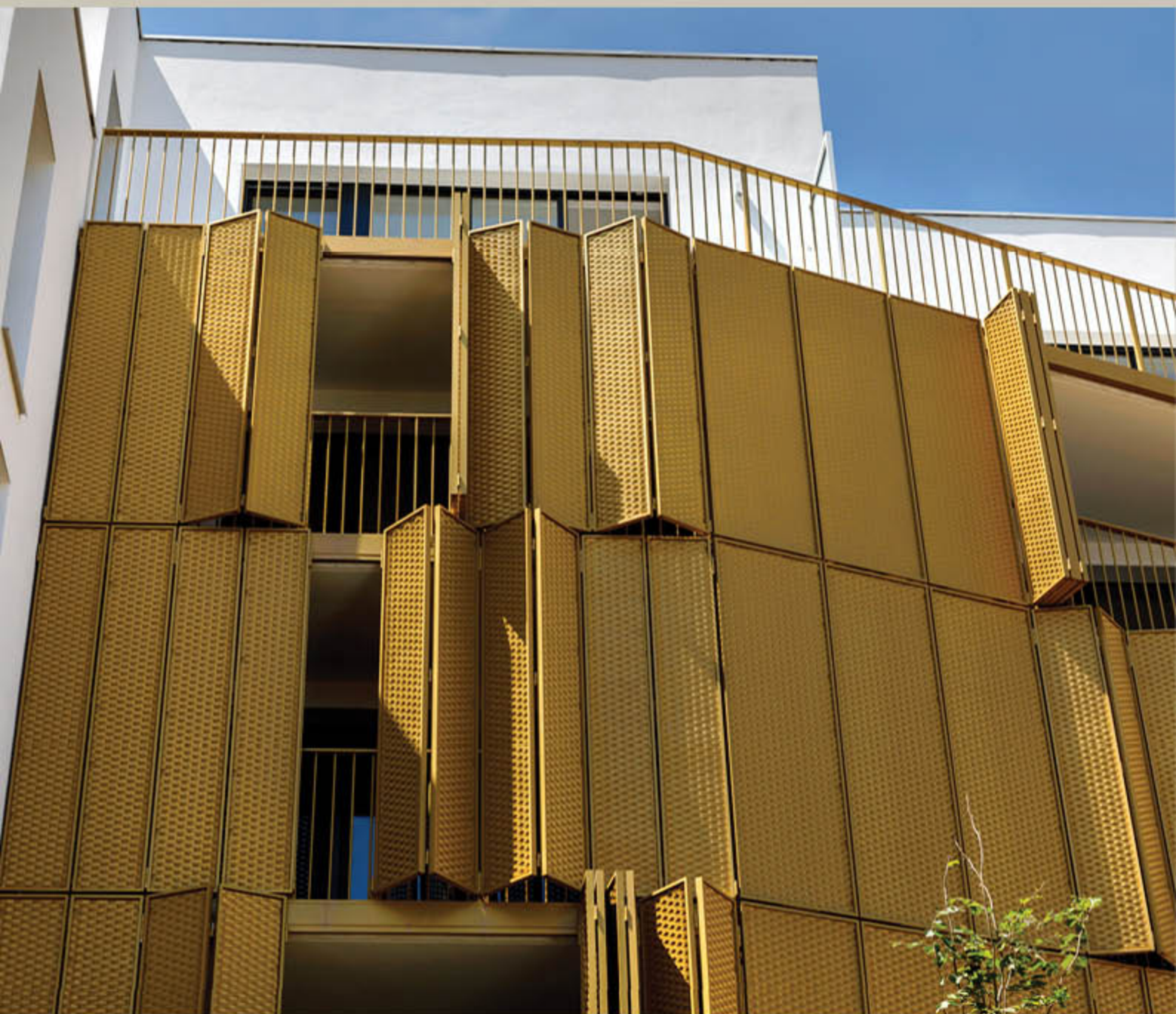

# FOLDING SHUTTERS

TYPE FPE

This is a shading system where individual panels are attached to a mechanism with specialised hinges. When the shutters are closed, the integrant panels can cover the guides entirely. Profiles are made from aluminium and parts from stainless steel.

This system allows the shutters to be always aligned with the facade and can cover the whole facade.

Cross section drawing over folding panels

**FACADE  
WALL  
FIXATION**



**CEILING  
VISIBLE  
FIXATION**



**CEILING  
HIDDEN  
FIXATION**



# FOLDING SHUTTERS

## TYPE FPE CONFIGURATIONS

FOLDING SHUTTERS

TYPE FPE

CEILING HIDDEN FIXATION

2 PANELS

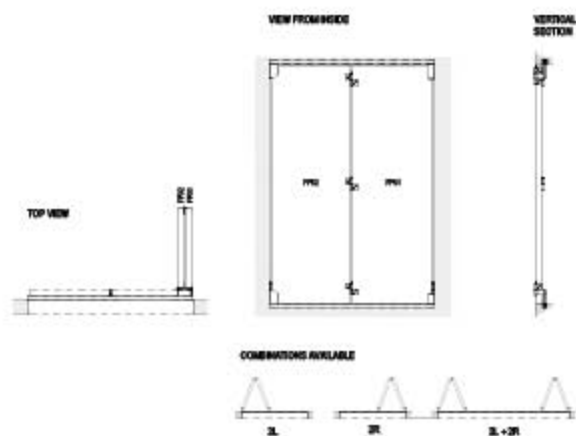

FOLDING SHUTTERS

TYPE FPE

CEILING HIDDEN FIXATION

4 PANELS

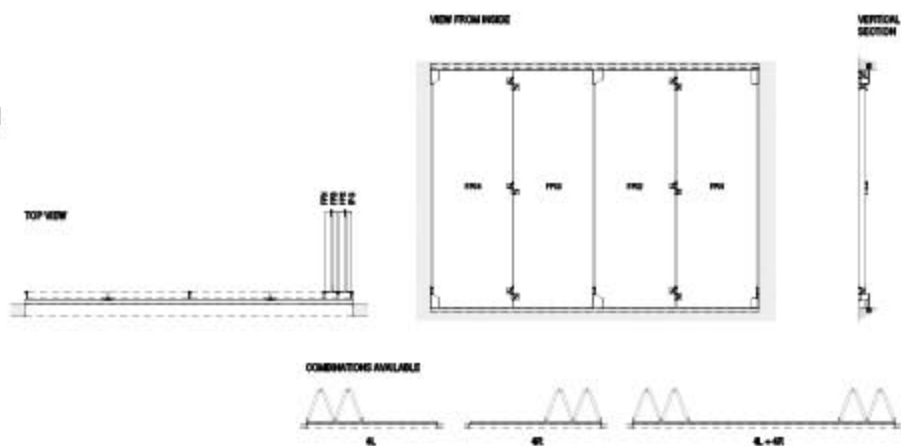

FOLDING SHUTTERS

TYPE FPE

CEILING HIDDEN FIXATION

6 PANELS

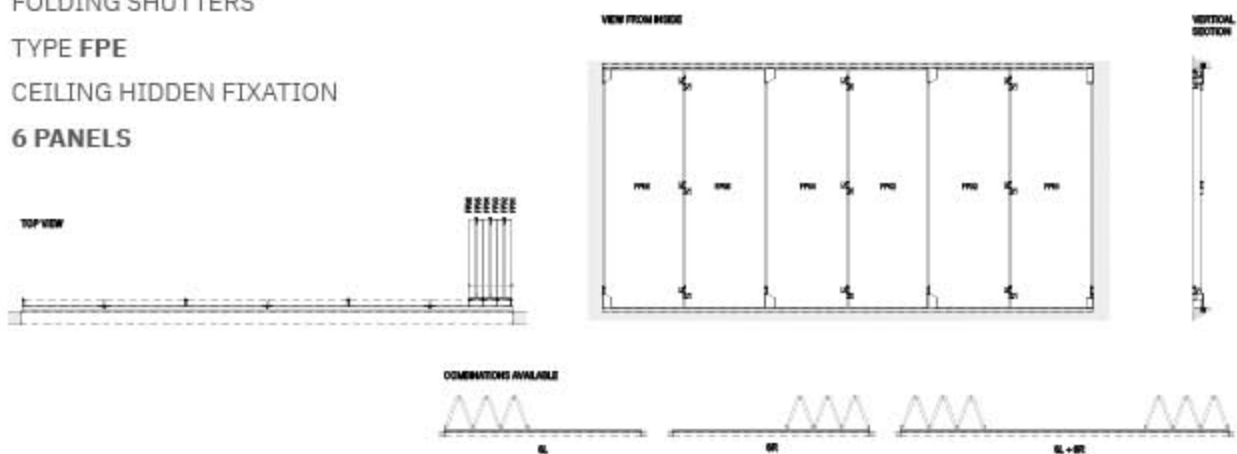

# FOLDING SHUTTERS

MOTORIZED VARIANT OF FPE

TYPE FPE M

Linear motors are used in the Driving mechanism of motorised folding shutters.

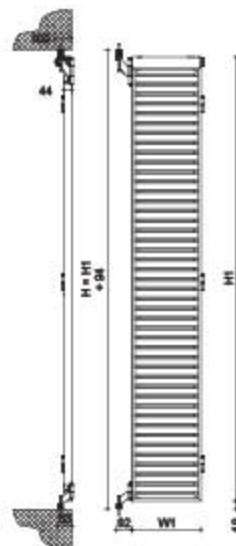
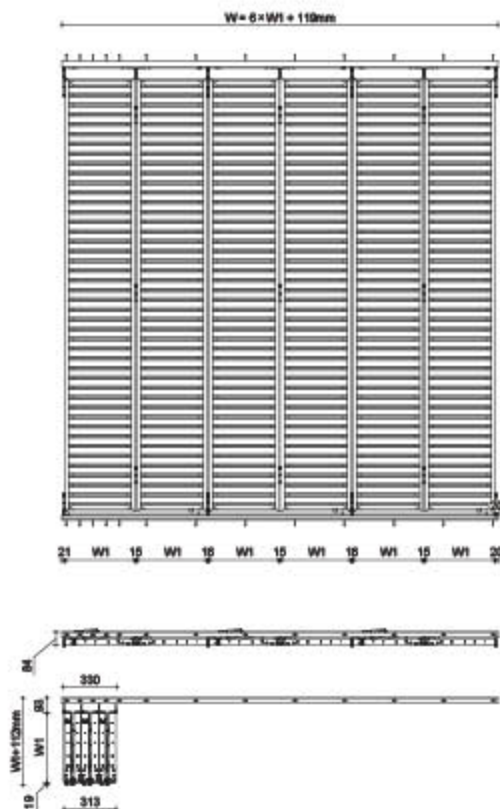

FOLDING SHUTTERS  
TYPE FPE M  
MOTORIZED  
6 PANELS

# FOLDING SHUTTERS

## TYPE FPE M CONFIGURATIONS

FOLDING SHUTTERS  
TYPE FPE M  
MOTORIZED  
4 PANELS

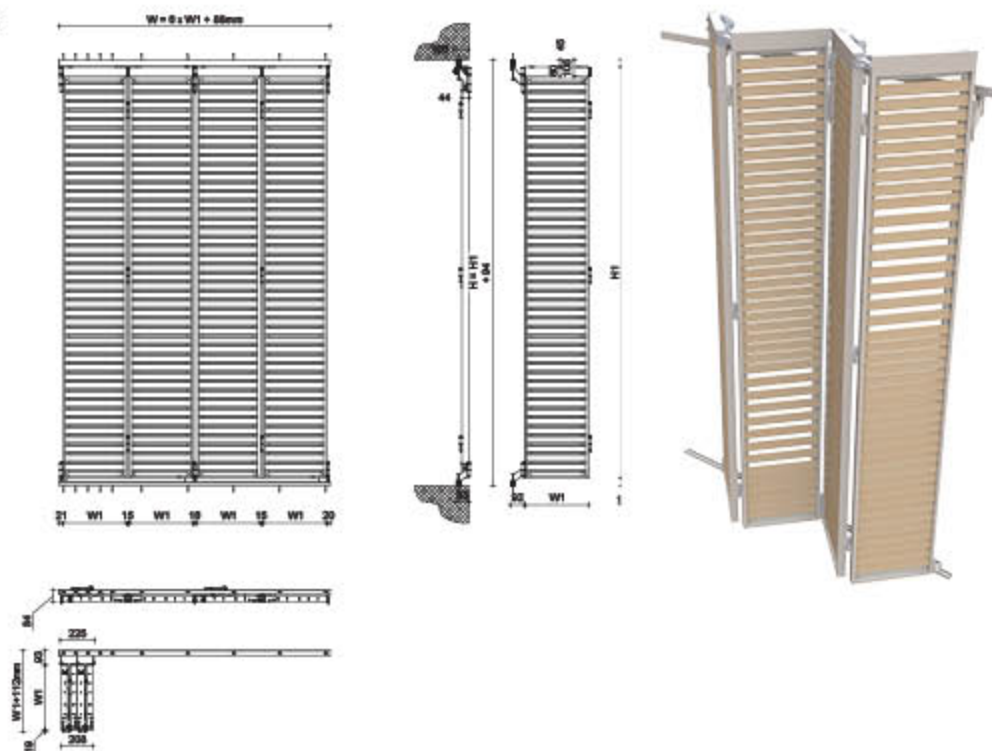

FOLDING SHUTTERS  
TYPE FPE M  
MOTORIZED  
4 PANELS

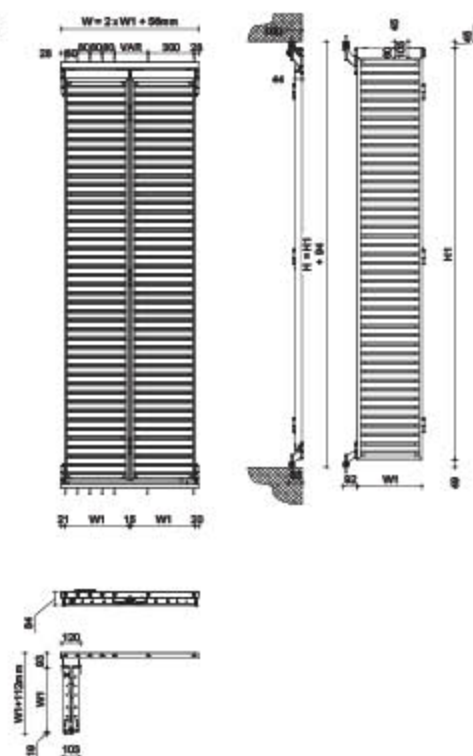



# FOLDING SHUTTERS

DIMENSIONS

TYPE FPE M

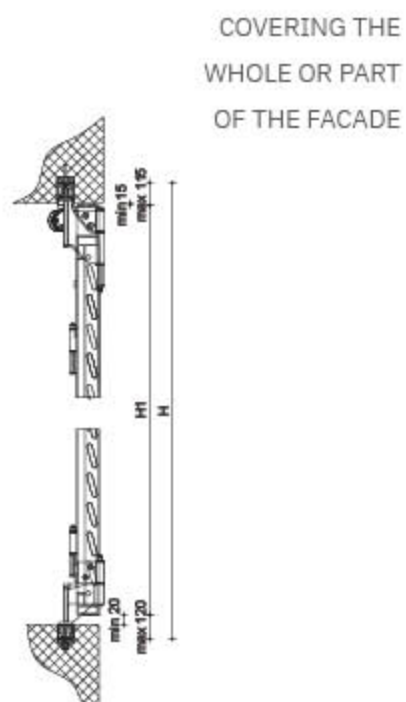
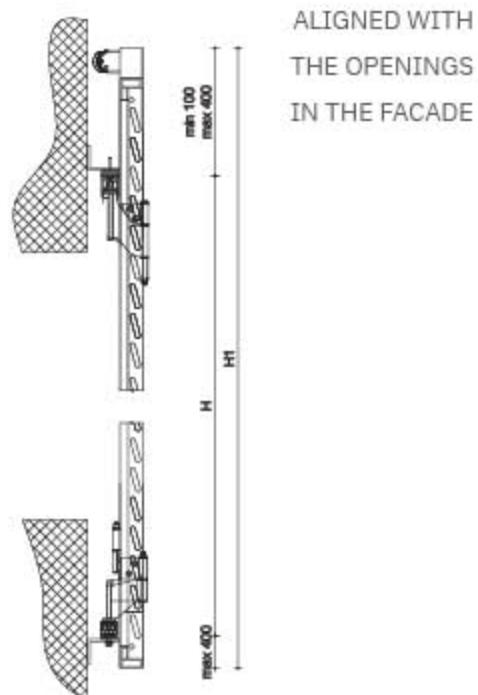





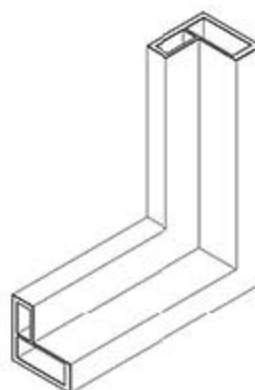



# FRAME

TYPE **FPE LQ44** | FOLDING SHUTTERS







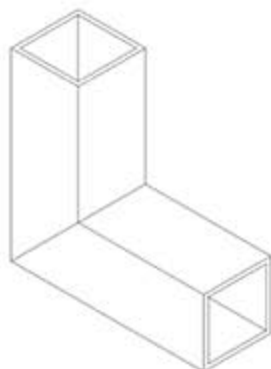

Class 6 wind resistance according to EN 13659

	Infill	Min. width [mm]	Max. width [mm]	Min. height [mm]	Max. height [mm]	Max. area [m <sup>2</sup> ]
LQ44 INFILL A	 Alu slats Oval	300	700	800	3200	2.0
LQ44 INFILL B	 Alu slats Square	300	700	800	3200	1.9
LQ44 INFILL C1	 One side Alu sheet	300	600	800	3200	1.9
LQ44 INFILL C2	 Double side Alu sheet	300	600*	800	3500	2.1
LQ44 INFILL D1	 One side perforated Alu sheet	300	600	800	3200	1.9
LQ44 INFILL D2	 Double side perforated Alu sheet	300	600*	800	3500	2.1
LQ44 INFILL E	 Expanded Alu sheet	300	700	800	3200	2.0
LQ44 INFILL F	 Fundermax plates	300	700	800	3200	2.0
LQ44 INFILL G	 Wood slats 70/20	300	700	800	3200	2.0

# FRAME

FOLDING SHUTTERS | TYPE FPE Q40



	Infill	Min. width [mm]	Max. width [mm]	Min. height [mm]	Max. height [mm]	Max. area [m <sup>2</sup> ]
Q40 INFILL C1	 One side Alu sheet	300	600	800	3200	1.9
Q40 INFILL C2	 Double side Alu sheet	300	600*	800	3500	2.1
Q40 INFILL D1	 One side perforated Alu sheet	300	600	800	3200	1.9
Q40 INFILL D2	 Double side perforated Alu sheet	300	600*	800	3500	2.1
Q40 INFILL F	 Fundermax plates	300	700	800	3200	2.2
Q40 INFILL G	 Wood slats before frame 70/20	300	700	800	3200	2.2

\* Alu sheet and Alu perforated sheet can be used on span up to 900 mm, in case of use of bigger thickness of 2 mm and 3 mm respectively

\*\* Specific resistance studies or system adaptations are required for balcony side shutters, loggia closures, free bay closures or when distance from shutter to fixed window/facade is greater

\*\*\* For specific H/W dimensions look at the price table. Possible dimensions for use are non blank.



# FOLDING SHUTTERS

TYPE FPC

This is a system of folding shutters where the panels are attached to a mechanism within the panel's frame. The guide is installed above the panel visible, if not integrated into the loggia ceiling. Profiles are made from aluminium. Other metal parts are from stainless steel.

Cross section drawing over folding panels

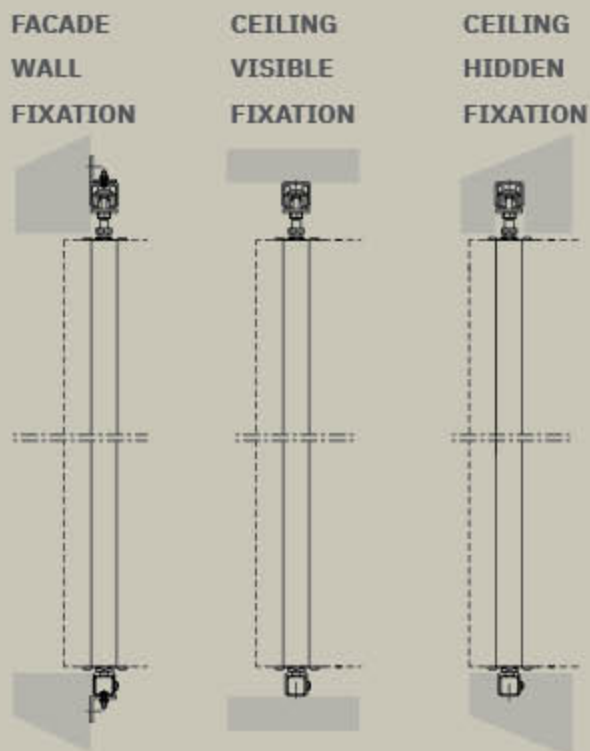

# FOLDING SHUTTERS

## TYPE FPC CONFIGURATIONS

### FOLDING SHUTTERS

#### TYPE FPC

#### 2 PANELS

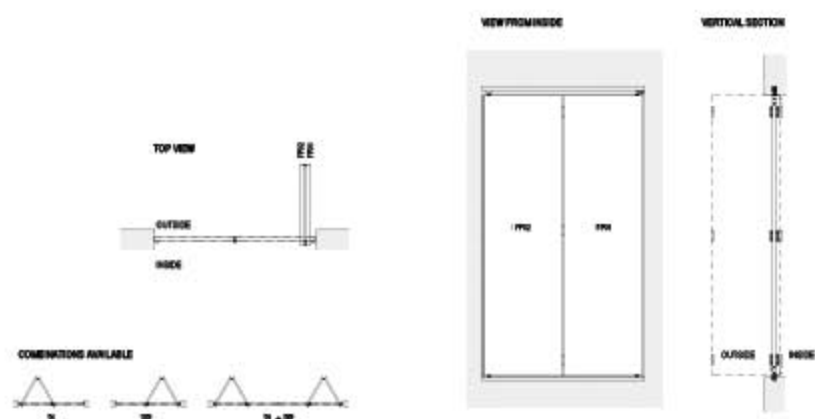

### FOLDING SHUTTERS

#### TYPE FPC

#### 4 PANELS

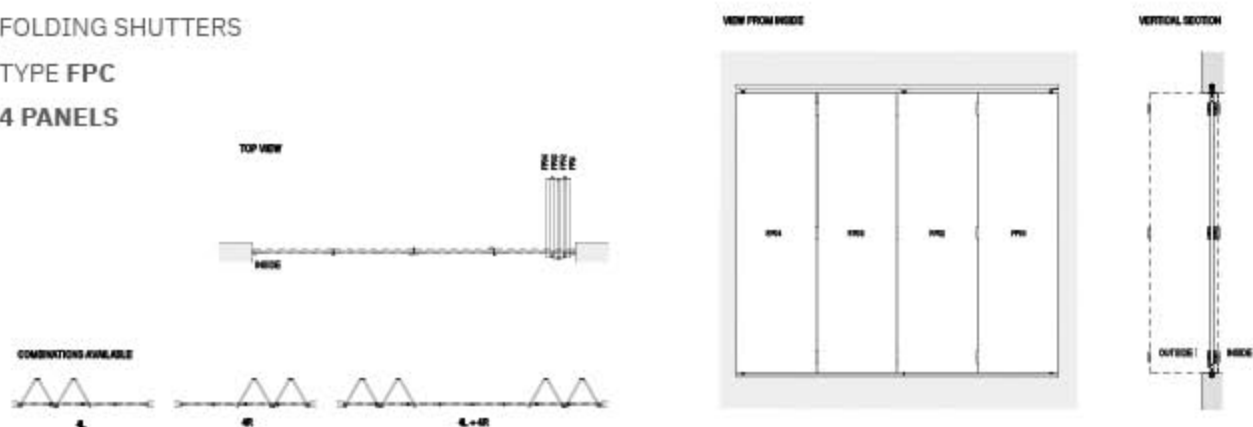

### FOLDING SHUTTERS

#### TYPE FPC

#### 6 PANELS

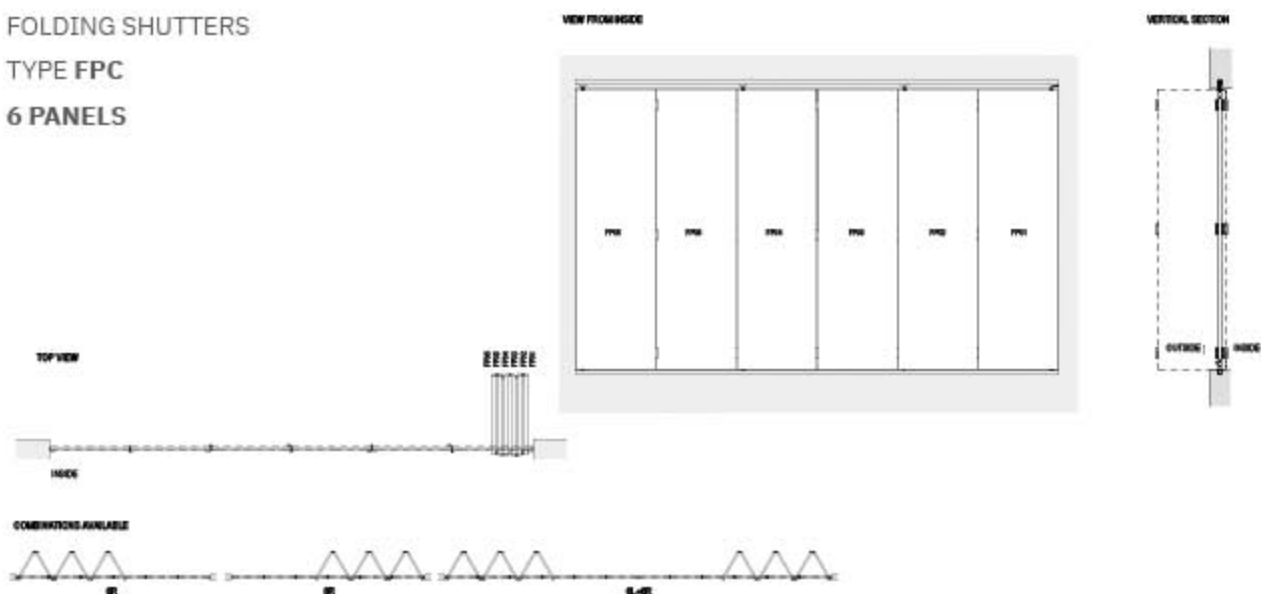

# FOLDING SHUTTERS

DIMENSIONS

TYPE FPC |

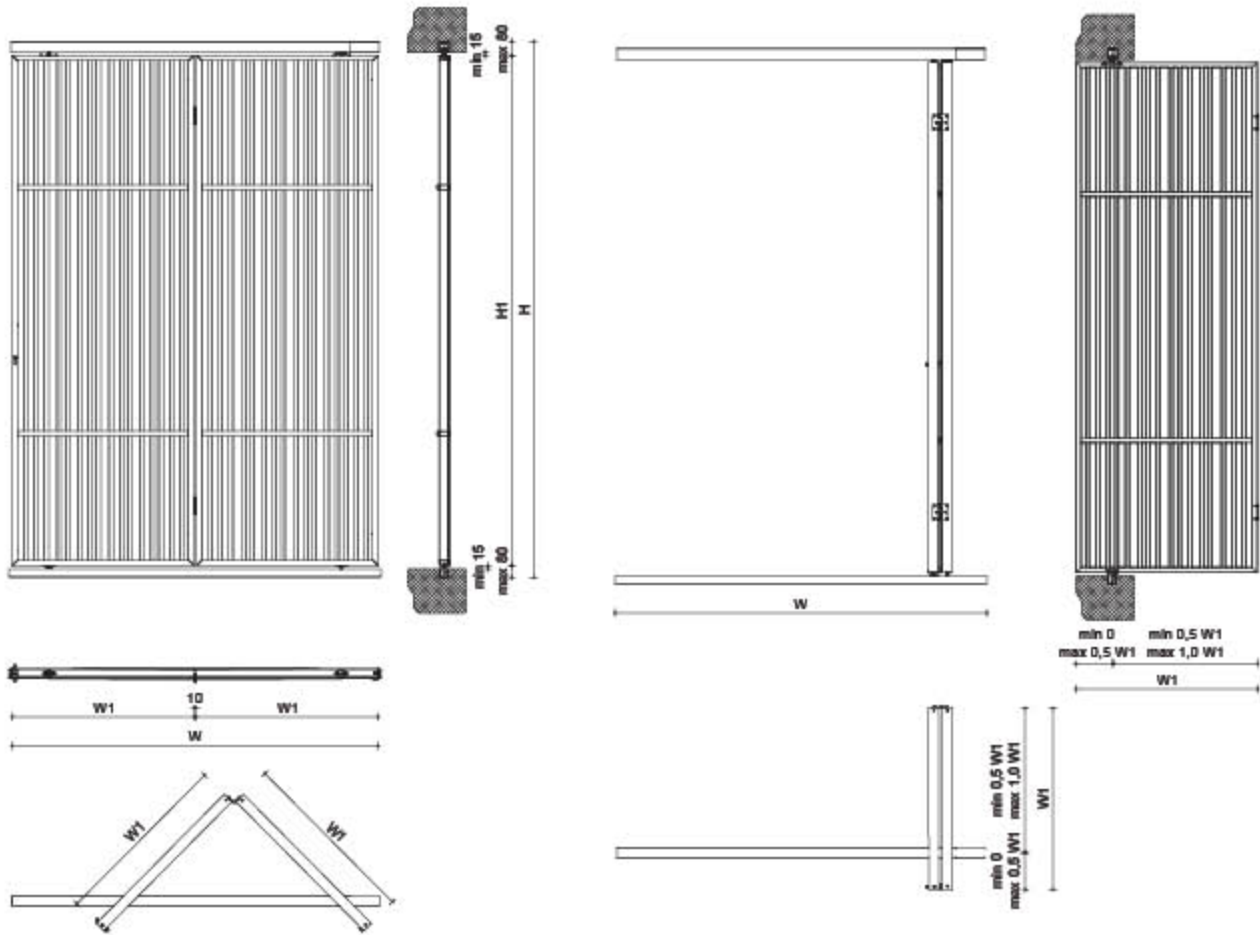





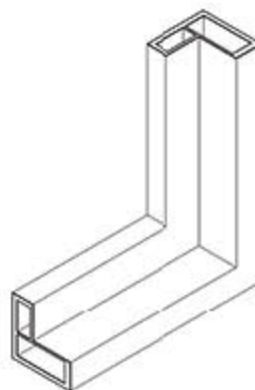



# FRAME

TYPE **FPC LQ44** | FOLDING SHUTTERS



Class 6 wind resistance according to EN 13659

	Infill	Min. width [mm]	Max. width [mm]	Min. height [mm]	Max. height [mm]	Max. area [m <sup>2</sup> ]
LQ44 INFILL A	 Alu slats Oval	300	700	800	3200	2.0
LQ44 INFILL B	 Alu slats Square	300	700	800	3200	1.9
LQ44 INFILL C1	 One side Alu sheet	300	600	800	3200	1.9
LQ44 INFILL C2	 Double side Alu sheet	300	600*	800	3500	2.1
LQ44 INFILL D1	 One side perforated Alu sheet	300	600	800	3200	1.9
LQ44 INFILL D2	 Double side perforated Alu sheet	300	600*	800	3500	2.1
LQ44 INFILL E	 Expanded Alu sheet	300	700	800	3200	2.0
LQ44 INFILL F	 Fundermax plates	300	700	800	3200	2.0
LQ44 INFILL G	 Wood slats 70/20	300	700	800	3200	2.0



# FRAME

FOLDING SHUTTERS | TYPE FPC Q40

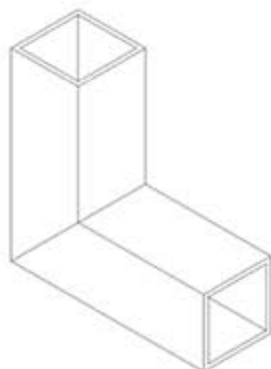

	Infill	Min. width [mm]	Max. width [mm]	Min. height [mm]	Max. height [mm]	Max. area [m <sup>2</sup> ]
Q40 INFILL C1	One side Alu sheet	300	600	800	3200	1.9
Q40 INFILL C2	Double side Alu sheet	300	600*	800	3500	2.1
Q40 INFILL D1	One side perforated Alu sheet	300	600	800	3200	1.9
Q40 INFILL D2	Double side perforated Alu sheet	300	600*	800	3500	2.1
Q40 INFILL F	Fundermax plates	300	700	800	3200	2.2
Q40 INFILL G	Wood slats before frame 70/20	300	700	800	3200	2.2

\* Alu sheet and Alu perforated sheet can be used on span up to 900 mm, in case of use of bigger thickness of 2 mm and 3 mm respectively

\*\* Specific resistance studies or system adaptations are required for balcony side shutters, loggia closures, free bay closures or when distance from shutter to fixed window/facade is greater

\*\*\* For specific H/W dimensions look at the price table. Possible dimensions for use are non blank.

# WIND SITUATIONS

EXAMPLES FOR OPEN POSITIONS IN WIND SITUATIONS



## PARTIAL (1/3 W1) SASH WIND EXPOSURE

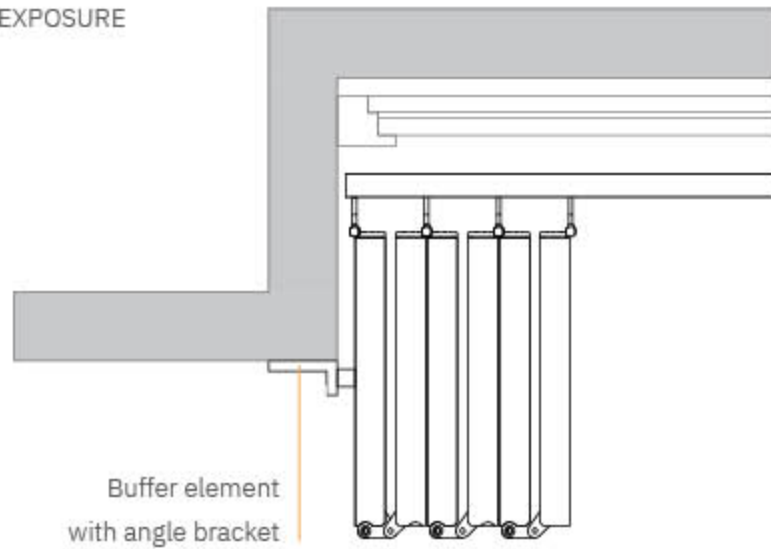

## NO SASH WIND EXPOSURE

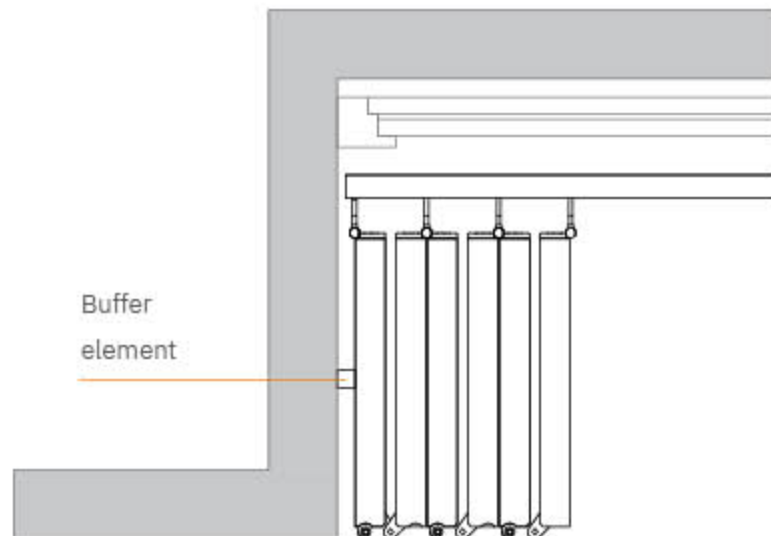

# WIND SITUATIONS

EXAMPLES FOR OPEN POSITIONS IN WIND SITUATIONS

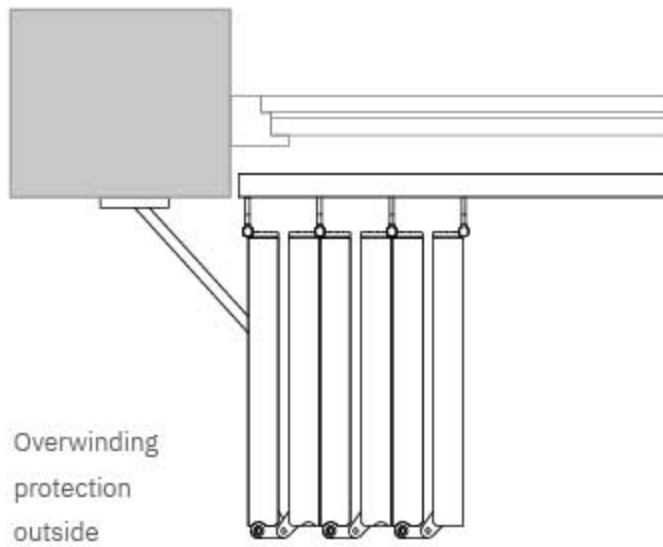

Overwinding  
protection  
outside

**COMPLETE SASH WIND EXPOSURE**

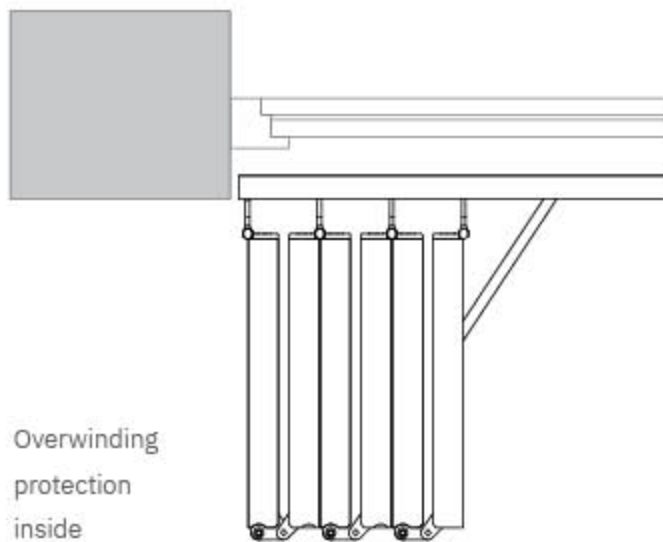

Overwinding  
protection  
inside

**COMPLETE SASH WIND EXPOSURE**



#### SLIDING SHUTTERS | TYPE SPH

Panels are hung on the upper guide and guided on lateral rollers on the lower guide



#### SLIDING SHUTTERS | TYPE SPR

Panels have rollers to roll on the lower guide and guided on lateral rollers on the upper guide



#### SLIDING SHUTTERS | TYPE SPS

Panels are hung on the upper guide and guided sliding on the lower guide

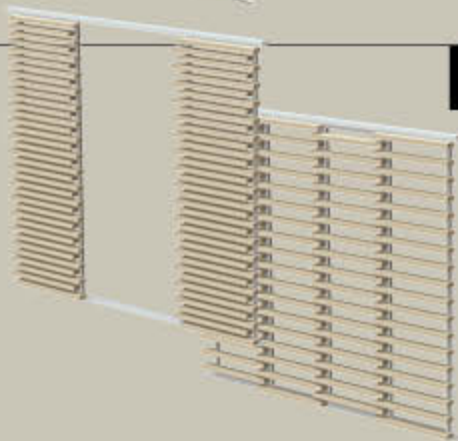

#### SLIDING SHUTTERS | TYPE SPC

Special overlapping variant of sliding shutters. Both variants hung/on rollers are possible.

# SLIDING SHUTTERS



# SLIDING SHUTTERS

TYPE SPH

In this system, the panels are attached to carriages installed in the upper guide. The panels hang, and the lower guide provides horizontal stability and guidance.

Cross section drawing over sliding panels, up to three guides available.

**FACADE  
WALL  
FIXATION**



**CEILING  
VISIBLE  
FIXATION**



**CEILING  
HIDDEN  
FIXATION**



# SLIDING SHUTTERS

## TYPE SPH CONFIGURATION

SLIDING SHUTTERS

TYPE SPH

1 PANEL

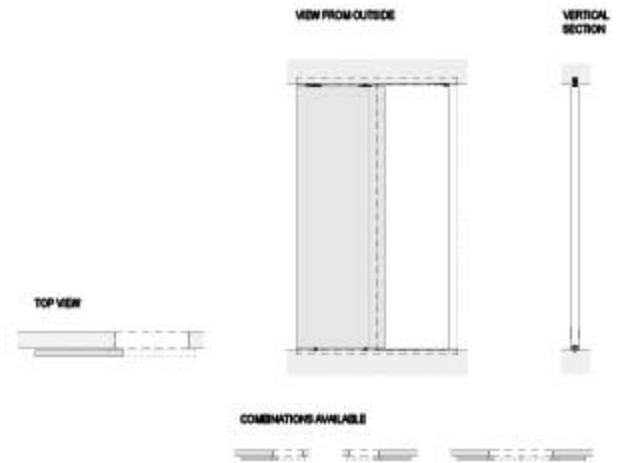

SLIDING SHUTTERS

TYPE SPH

2 PANELS

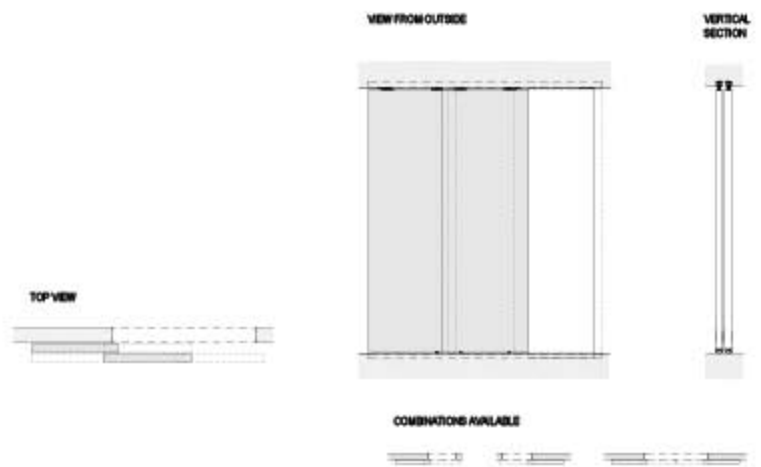

SLIDING SHUTTERS

TYPE SPH

3 PANELS

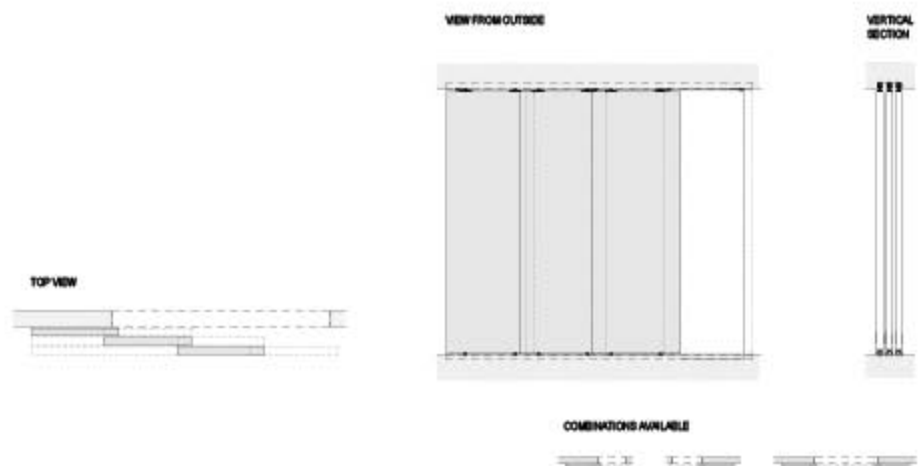



# SLIDING SHUTTERS

DIMENSIONS | TYPE SPH

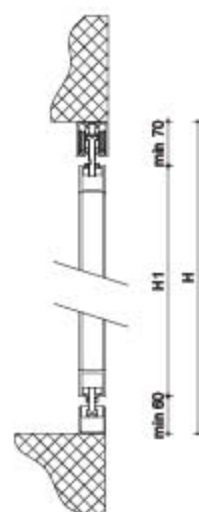
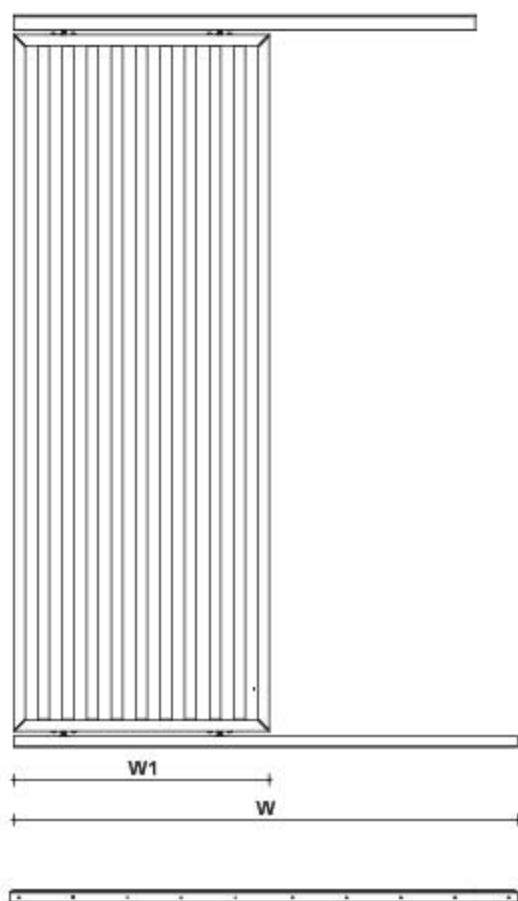





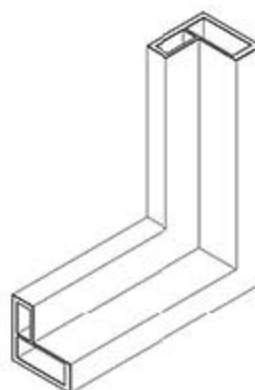



# FRAME

TYPE SPH LQ44 | SLIDING SHUTTERS



Class 6 wind resistance according to EN 13659







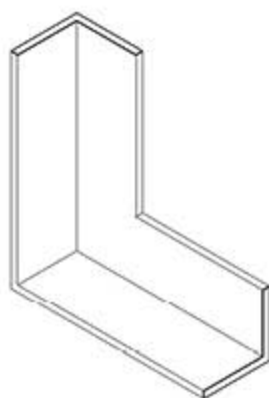

	Infill	Min. width [mm]	Max. width [mm]	Min. height [mm]	Max. height [mm]	Max. area [m <sup>2</sup> ]
L44 INFILL A	 Alu slats Oval	300	700	800	3200	2.0
L44 INFILL B	 Alu slats Square	300	700	800	3200	1.9
L44 INFILL C1	 One side Alu sheet	300	600	800	3200	1.9
L44 INFILL C2	 Double side Alu sheet	300	600*	800	3500	2.1
L44 INFILL D1	 One side perforated Alu sheet	300	600	800	3200	1.9
L44 INFILL D2	 Double side perforated Alu sheet	300	600*	800	3500	2.1
L44 INFILL E	 Expanded Alu sheet	300	700	800	3200	2.0
L44 INFILL F	 Fundermax plates	300	700	800	3200	2.0
L44 INFILL G	 Wood slats 70/20	300	700	800	3200	2.0

# FRAME

SLIDING SHUTTERS | TYPE SPH L50



Class 6 wind resistance according to EN 13659







	Infill	Min. width [mm]	Max. width [mm]	Min. height [mm]	Max. height [mm]	Max. area [m <sup>2</sup> ]
L50 INFILL A	 Alu slats Oval	300	700	800	3200	2.0
L50 INFILL B	 Alu slats Square	300	700	800	3200	1.9
L50 INFILL C1	 One side Alu sheet	300	600	800	3200	1.9
L50 INFILL C2	 Double side Alu sheet	300	600*	800	3500	2.1
L50 INFILL D1	 One side perforated Alu sheet	300	600	800	3200	1.9
L50 INFILL D2	 Double side perforated Alu sheet	300	600*	800	3500	2.1
L50 INFILL E	 Expanded Alu sheet	300	700	800	3200	2.0
L50 INFILL F	 Fundermax plates	300	700	800	3200	2.0
L50 INFILL G	 Wood slats 70/20	300	700	800	3200	2.0

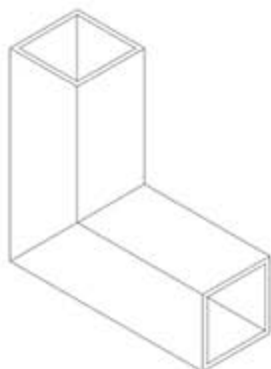

# FRAME

TYPE **SPH Q40** | SLIDING SHUTTERS



	Infill	Min. width [mm]	Max. width [mm]	Min. height [mm]	Max. height [mm]	Max. area [m <sup>2</sup> ]
Q40 INFILL C1	 One side Alu sheet	300	600	800	3200	1.9
Q40 INFILL C2	 Double side Alu sheet	300	600*	800	3500	2.1
Q40 INFILL D1	 One side perforated Alu sheet	300	600	800	3200	1.9
Q40 INFILL D2	 Double side perforated Alu sheet	300	600*	800	3500	2.1
Q40 INFILL F	 Fundermax plates	300	700	800	3200	2.2
Q40 INFILL G	 Wood slats before frame 70/20	300	700	800	3200	2.2

\* Alu sheet and Alu perforated sheet can be used on span up to 900 mm, in case of use of bigger thickness of 2 mm and 3 mm respectively

\*\* Specific resistance studies or system adaptations are required for balcony side shutters, loggia closures, free bay closures or when distance from shutter to fixed window/facade is greater

\*\*\* For specific H/W dimensions look at the price table. Possible dimensions for use are non blank.



# SLIDING SHUTTERS

TYPE SPS

In this system, the panels are attached to carriages installed in the upper guide. The panels hang on the upper guide and slide along the lower guide.

Cross section drawing over sliding panels, up to three guides available.

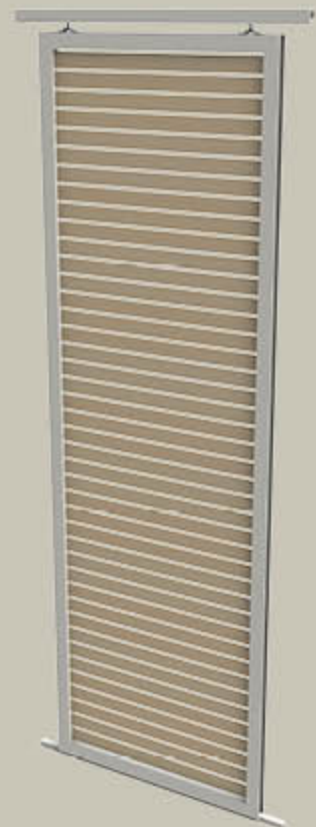
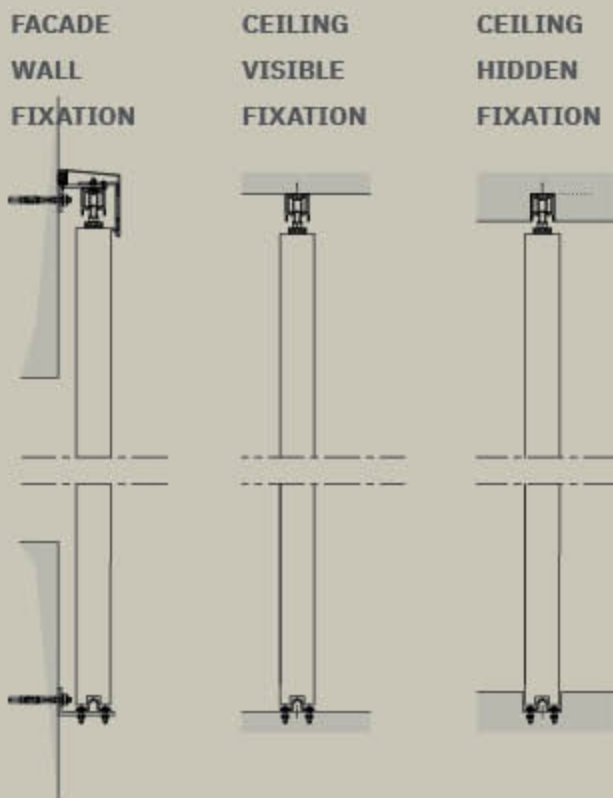

# SLIDING SHUTTERS

## TYPE SPH CONFIGURATION

SLIDING SHUTTERS

TYPE SPH

1 PANEL

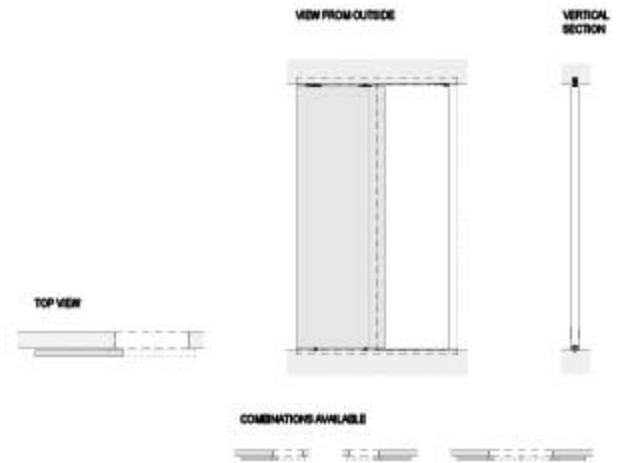

SLIDING SHUTTERS

TYPE SPH

2 PANELS

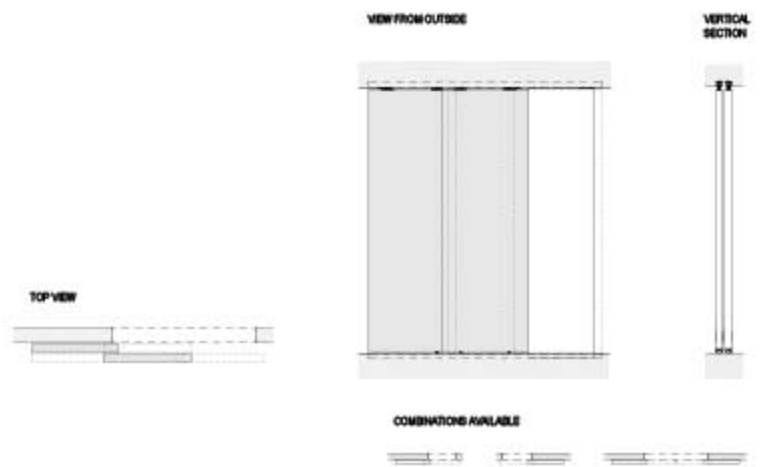

SLIDING SHUTTERS

TYPE SPH

3 PANELS

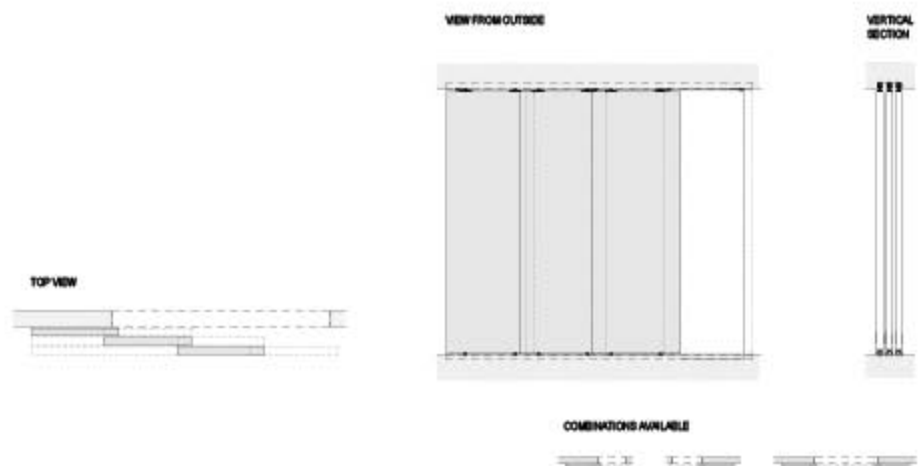



# SLIDING SHUTTERS

DIMENSIONS

TYPE SPS |

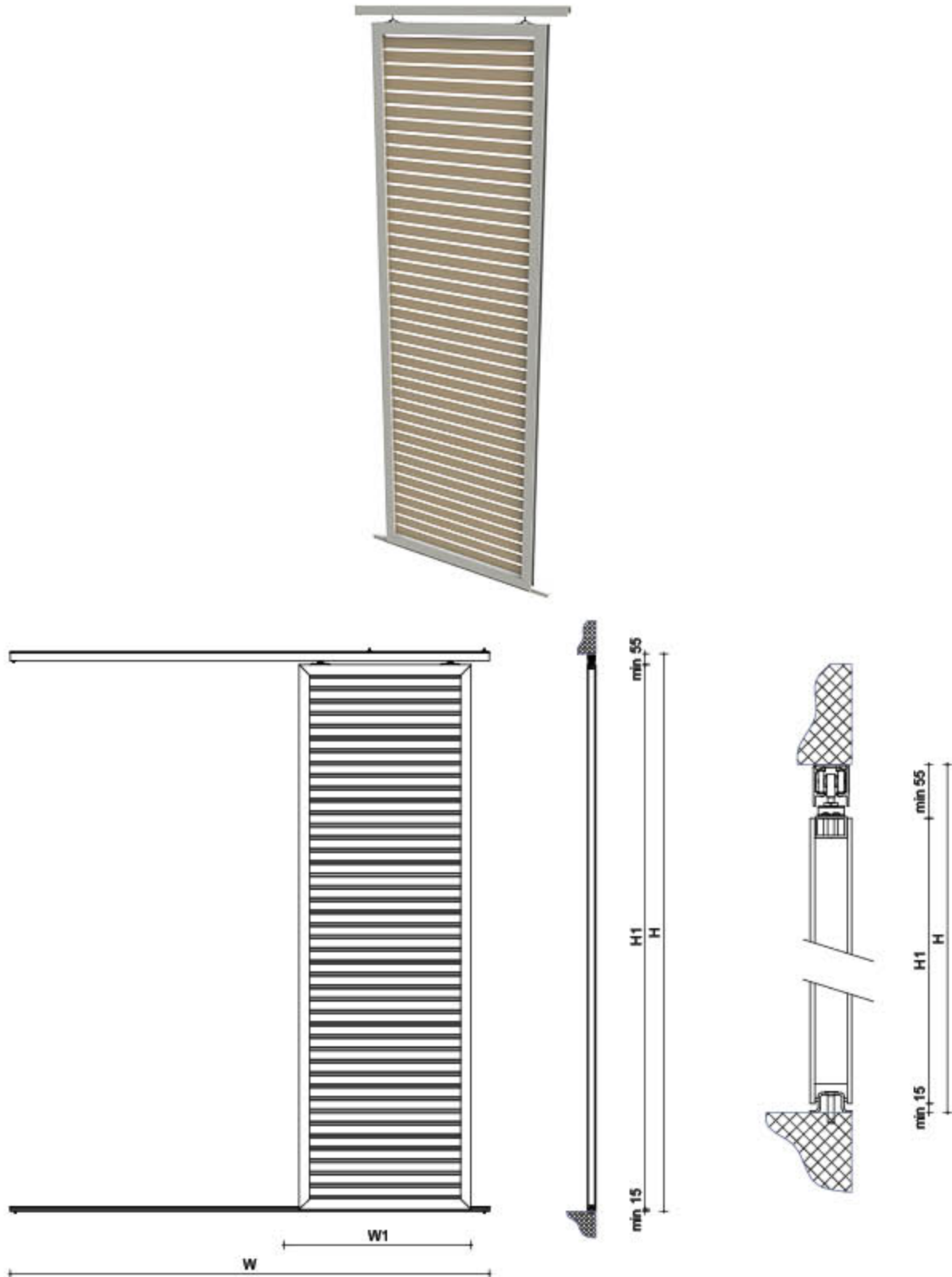







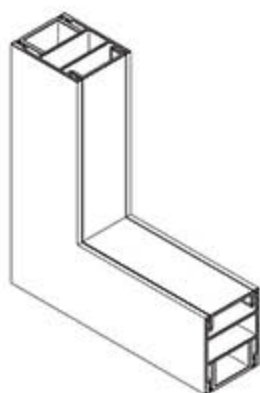

# FRAME

TYPE **SPH H50** | SLIDING SHUTTERS



	Infill	Min. width [mm]	Max. width [mm]	Min. height [mm]	Max. height [mm]	Max. area [m <sup>2</sup> ]
Q40 INFILL C1	 One side Alu sheet	300	600	800	3200	1.9
Q40 INFILL C2	 Double side Alu sheet	300	600*	800	3500	2.1
Q40 INFILL D1	 One side perforated Alu sheet	300	600	800	3200	1.9
Q40 INFILL D2	 Double side perforated Alu sheet	300	600*	800	3500	2.1
Q40 INFILL F	 Fundermax plates	300	700	800	3200	2.2
Q40 INFILL G	 Wood slats before frame 70/20	300	700	800	3200	2.2

\* Alu sheet and Alu perforated sheet can be used on span up to 900 mm, in case of use of bigger thickness of 2 mm and 3 mm respectively

\*\* Specific resistance studies or system adaptations are required for balcony side shutters, loggia closures, free bay closures or when distance from shutter to fixed window/facade is greater

\*\*\* For specific H/W dimensions look at the price table. Possible dimensions for use are non blank.



# SLIDING SHUTTERS XL

TYPE SPR

This system suits larger dimensions and heavy panels, as carriages are installed under the panel. The carriages roll on an oval bottom guide, while the upper guide provides horizontal stability and guidance for the panel.

Cross section drawing over sliding panels, up to three guides available.

**FACADE  
WALL  
FIXATION**



**CEILING  
VISIBLE  
FIXATION**



**CEILING  
HIDDEN  
FIXATION**

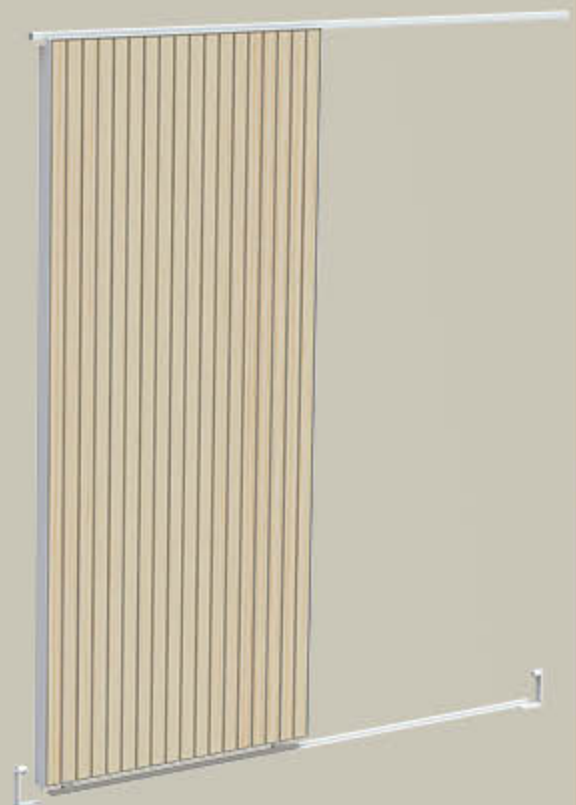

# SLIDING SHUTTERS XL

## TYPE SPR CONFIGURATIONS

SLIDING SHUTTERS

TYPE SPR

1 PANEL

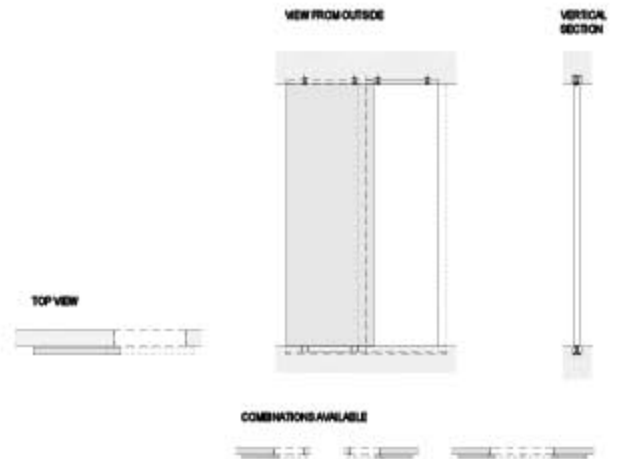

SLIDING SHUTTERS

TYPE SPR

2 PANELS

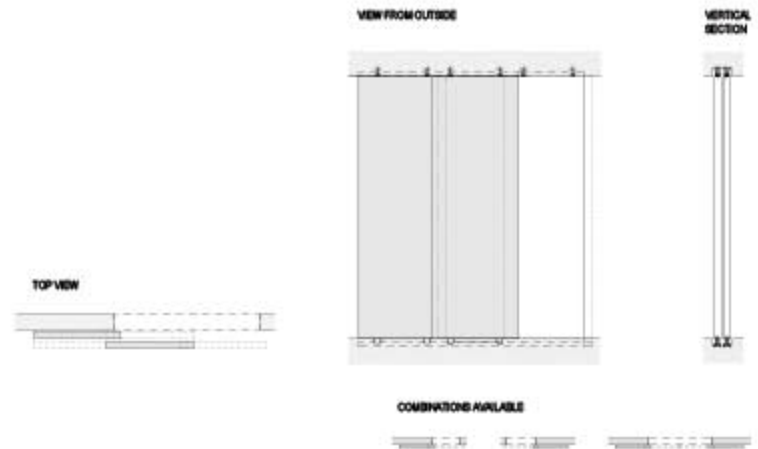

SLIDING SHUTTERS

TYPE SPR

3 PANELS

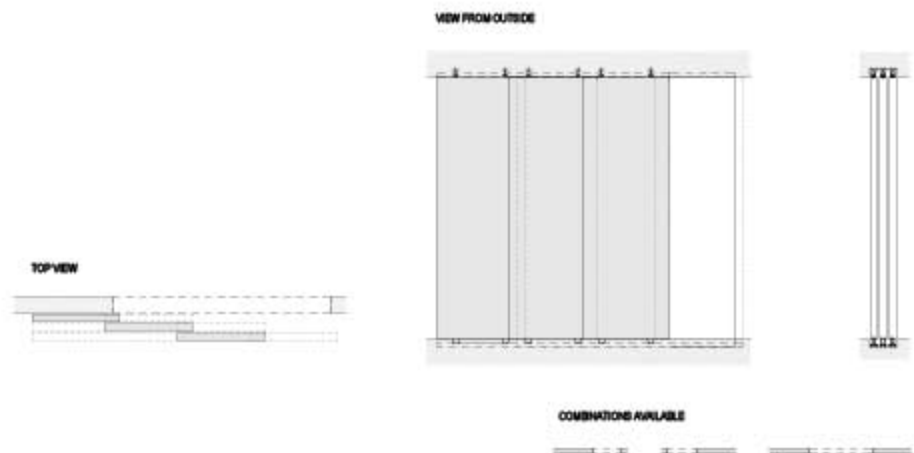

# SLIDING SHUTTERS XL

DIMENSIONS

TYPE SPR

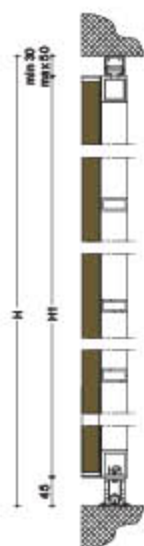
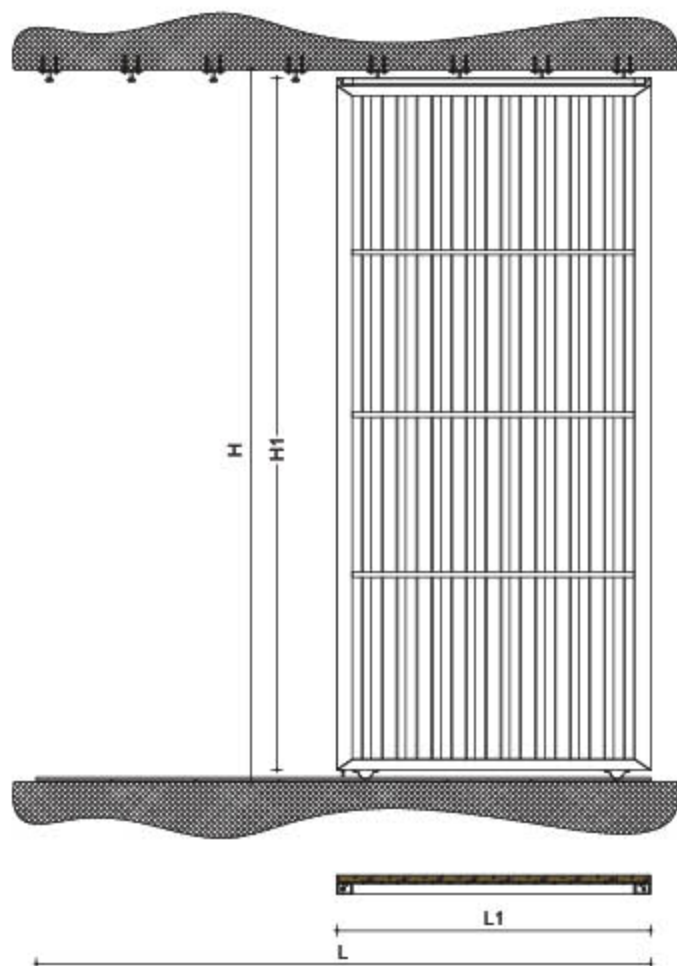





# FRAME

TYPE **SPR Q40** | SLIDING SHUTTERS

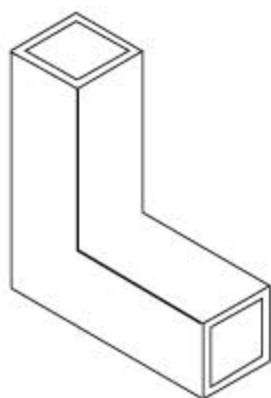

	Infill	Min. width [mm]	Max. width [mm]	Min. height [mm]	Max. height [mm]	Max. area [m <sup>2</sup> ]
Q40 INFILL C1	One side Alu sheet	300	600	800	3200	1.9
Q40 INFILL C2	Double side Alu sheet	300	600*	800	3500	2.1
Q40 INFILL D1	One side perforated Alu sheet	300	600	800	3200	1.9
Q40 INFILL D2	Double side perforated Alu sheet	300	600*	800	3500	2.1
Q40 INFILL F	Fundermax plates	300	700	800	3200	2.2
Q40 INFILL G	Wood slats before frame 70/20	300	700	800	3200	2.2

\* Alu sheet and Alu perforated sheet can be used on span up to 900 mm, in case of use of bigger thickness of 2 mm and 3 mm respectively

\*\* Specific resistance studies or system adaptations are required for balcony side shutters, loggia closures, free bay closures or when distance from shutter to fixed window/facade is greater

\*\*\* For specific H/W dimensions look at the price table. Possible dimensions for use are non blank.



# SLIDING SHUTTERS

TYPE SPC

Suitable for facade systems, with shutters overlapping technology. Both options are possible. Hung on the upper guide or sliding on rollers on the lower guide possible.

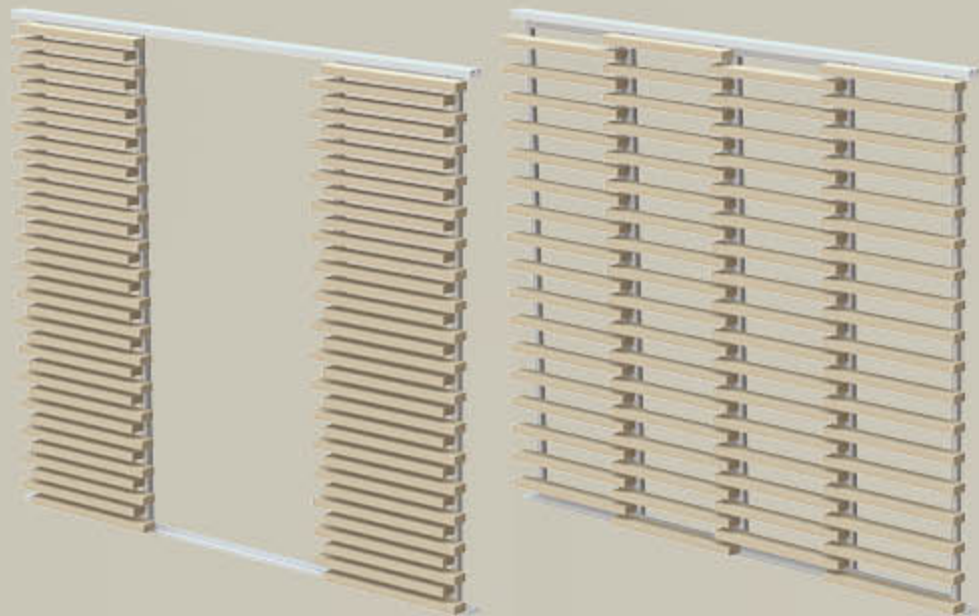

# SLIDING SHUTTERS

TYPE SPC

DIMENSIONS

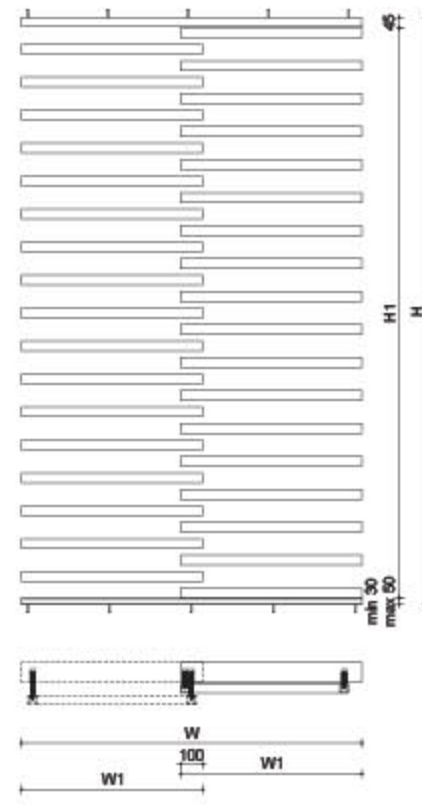
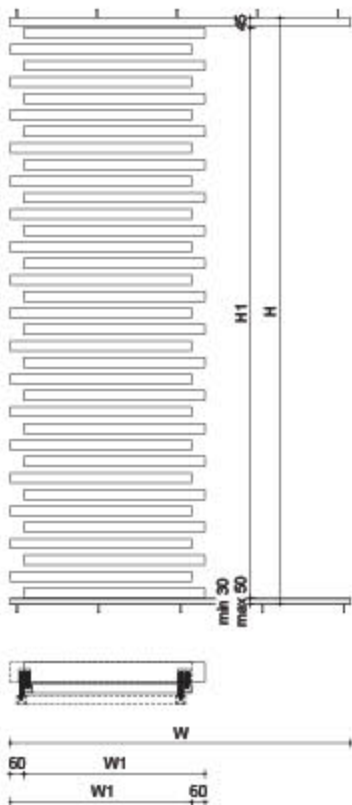
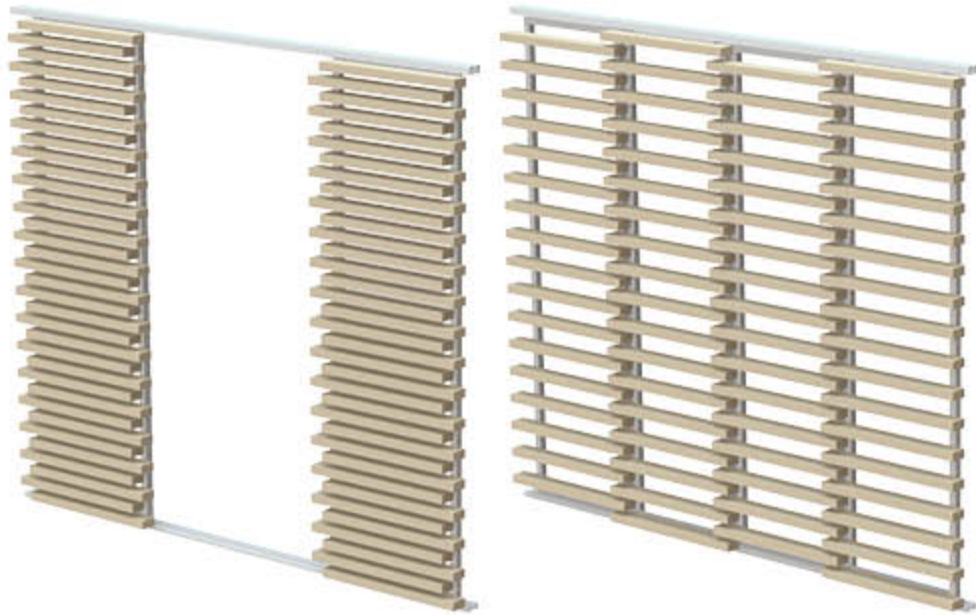

# SLIDING SHUTTERS

DIMENSIONS

TYPE SPC

OPTIONAL  
MOTORIZED  
VARIANT

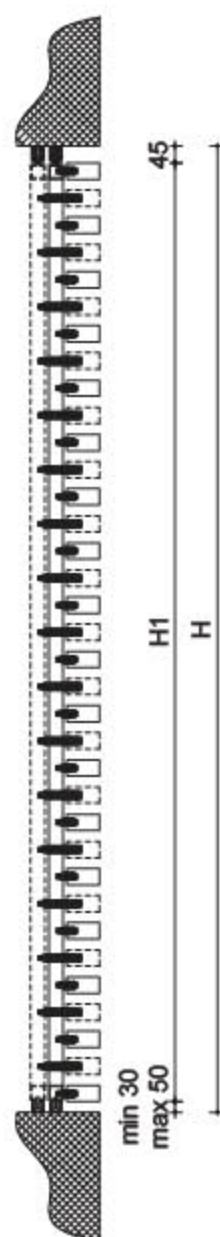
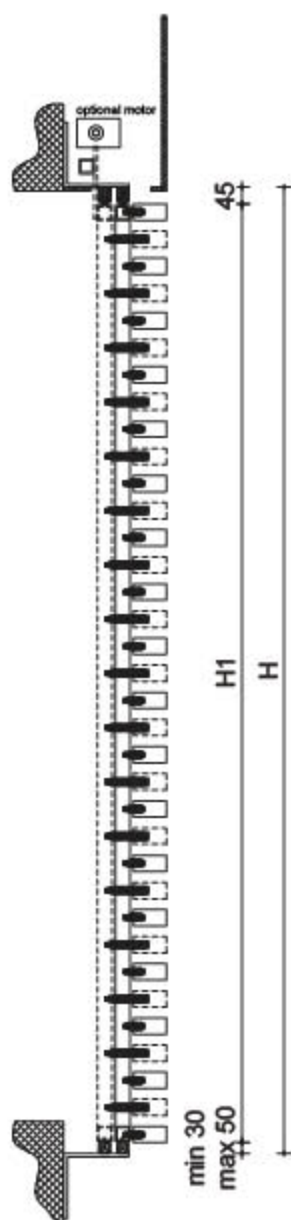



# FRAMES, PANELS & ACCESSORIES





# FRAME TYPES

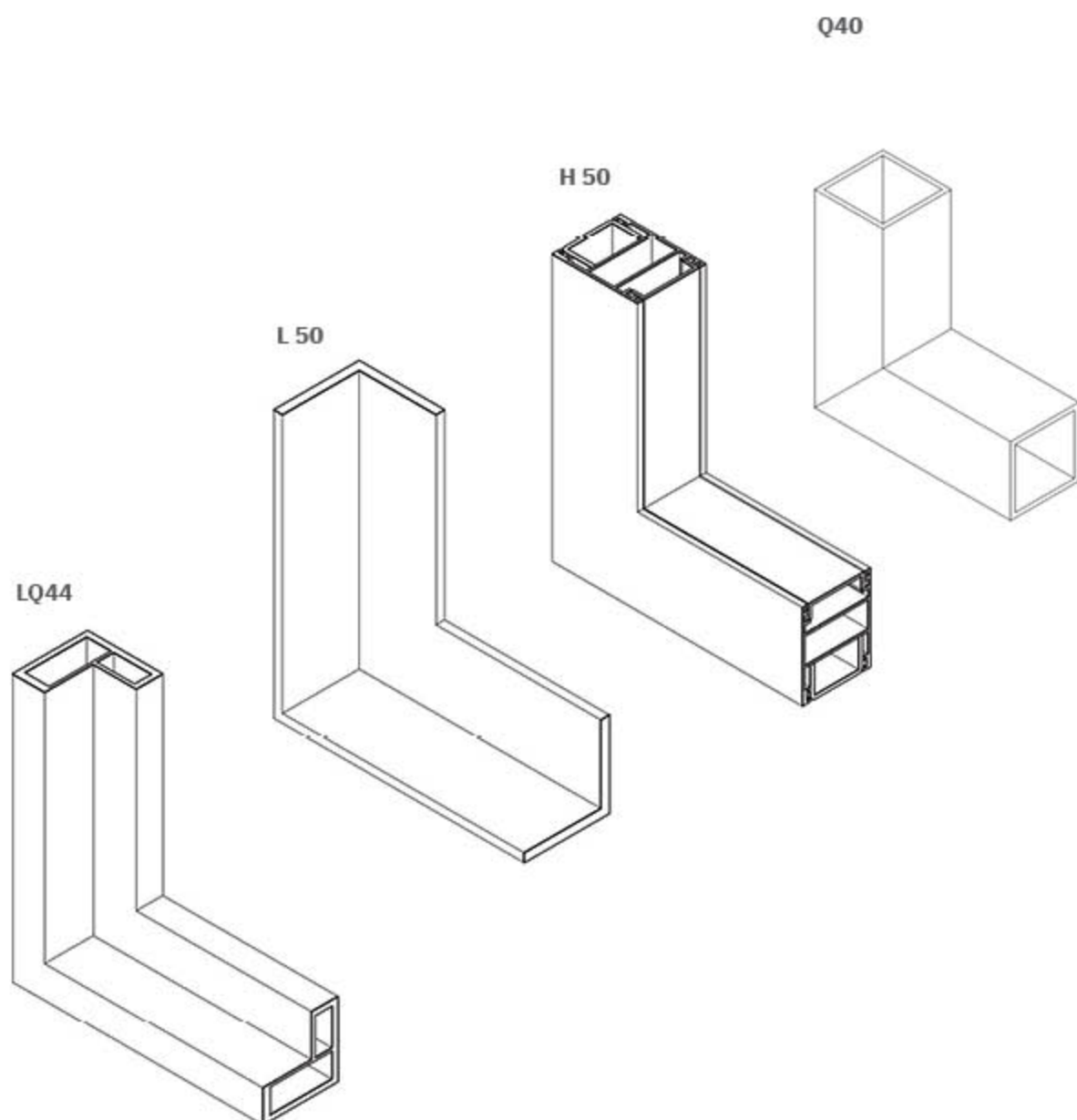



FRAME LQ44

INFILL B2: ALUMINIUM SLATS 20x20 SQUARE

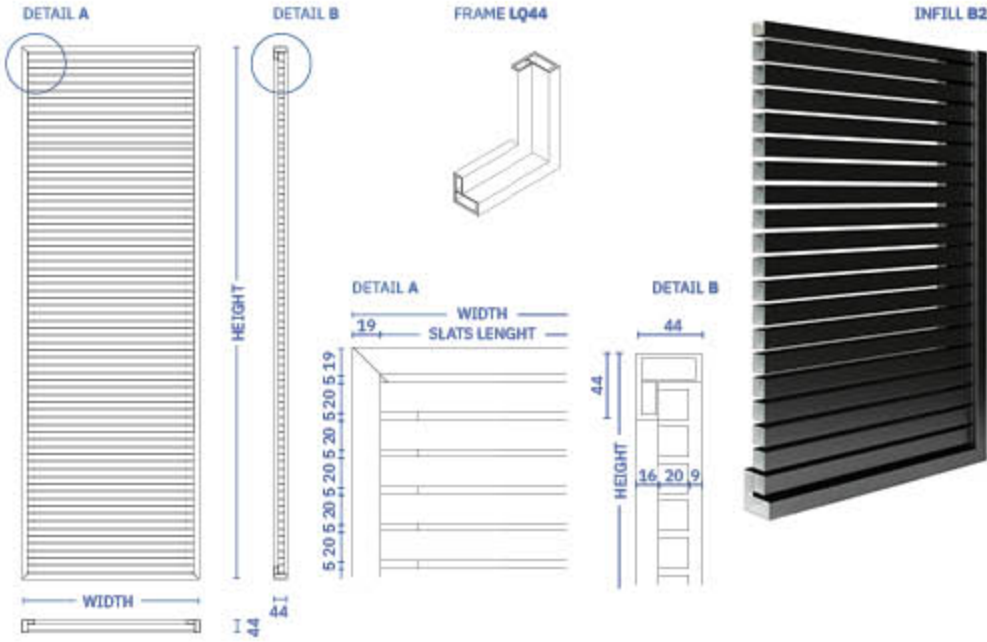

FRAME LQ44

INFILL B3: ALUMINIUM SLATS 20x20 SQUARE

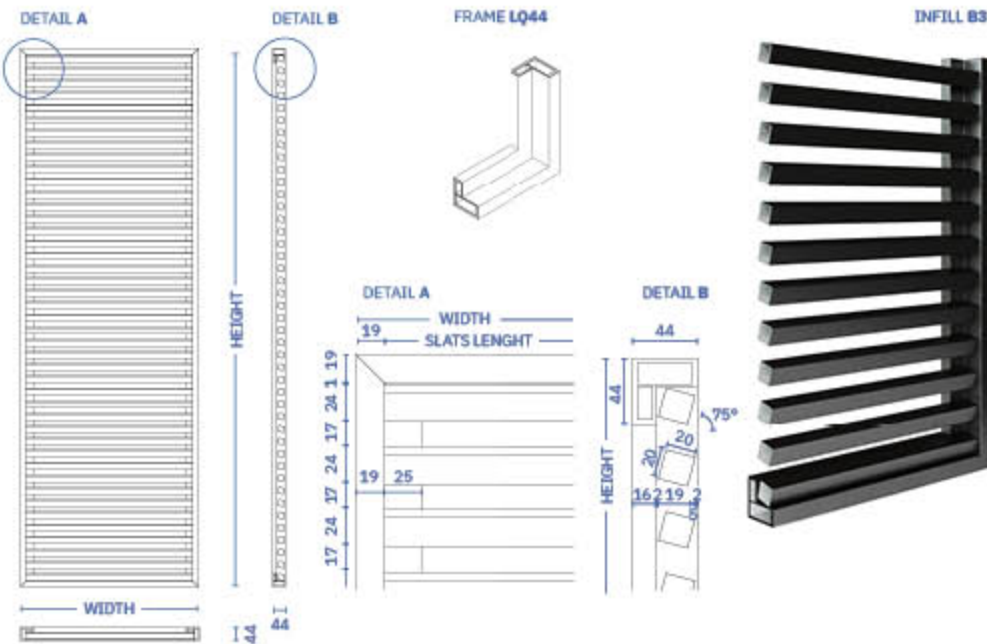

||| || FRAME LQ44

INFILL C1: ONE SIDE ALUMINIUM SHEET

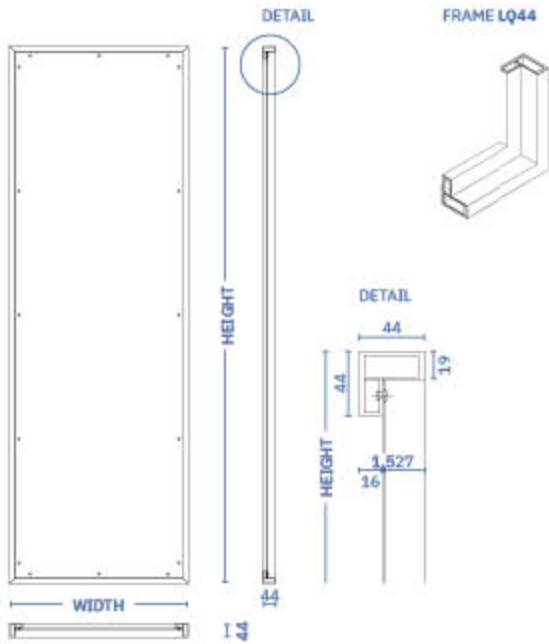

||| || FRAME LQ44

INFILL C2: DOUBLE SIDE ALUMINIUM SHEET

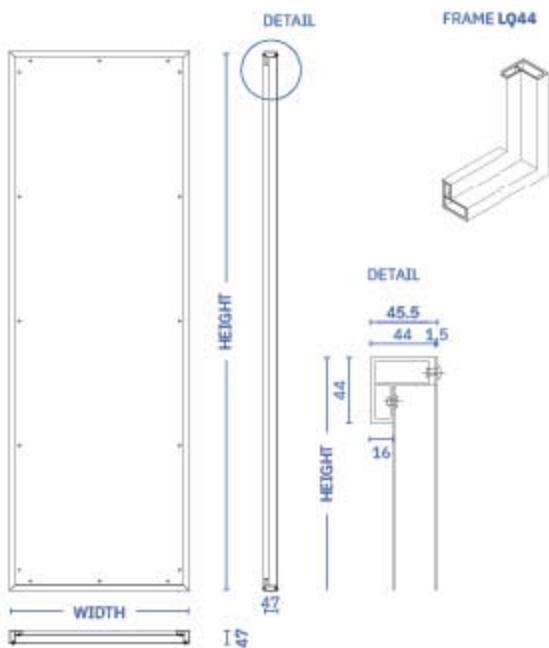

FRAME LQ44

INFILL C3: DOUBLE SIDE ALUMINIUM SHEET

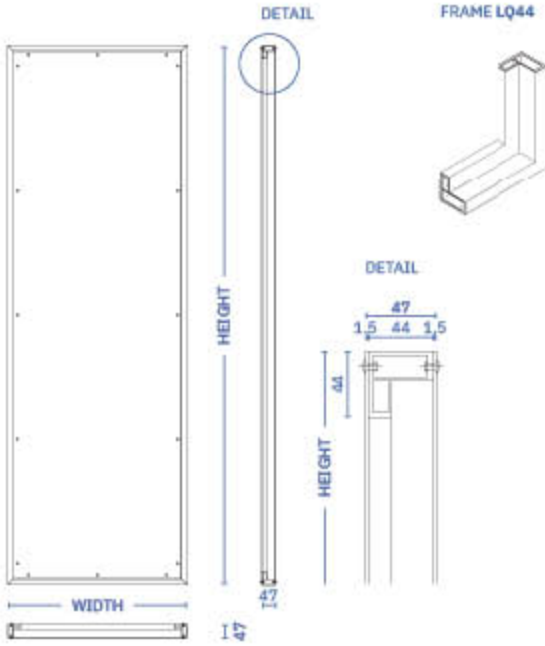

FRAME LQ44

INFILL D1: ONE SIDE ALUMINIUM PERFORATED SHEET

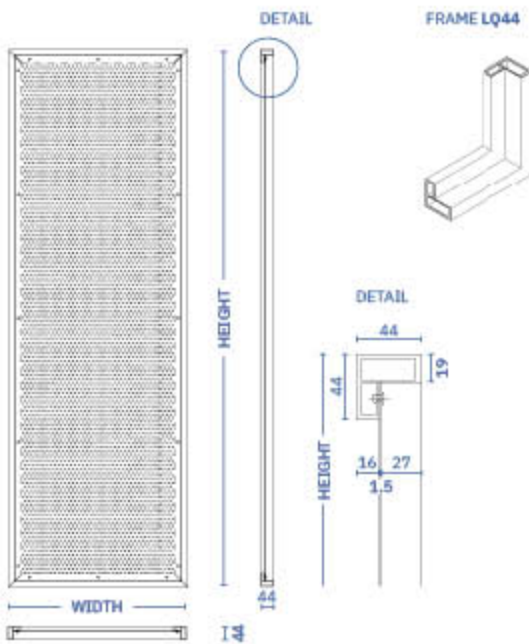

||| || FRAME LQ44

INFILL D2: DOUBLE SIDE ALUMINIUM PERFORATED SHEET

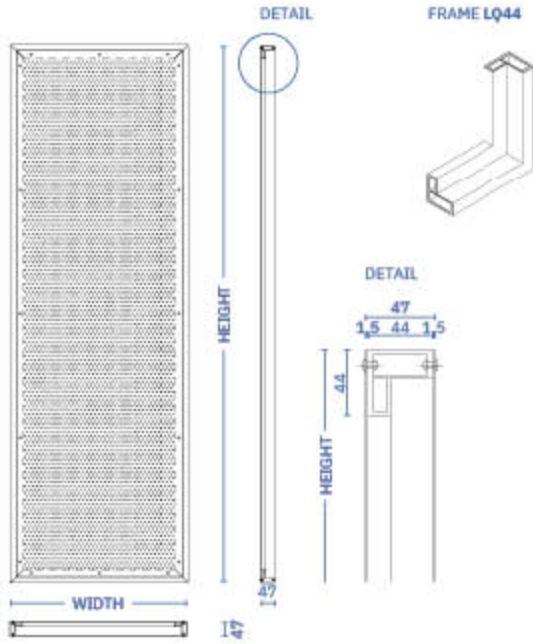

||| || FRAME LQ44

INFILL E: EXPANDED ALUMINIUM SHEET

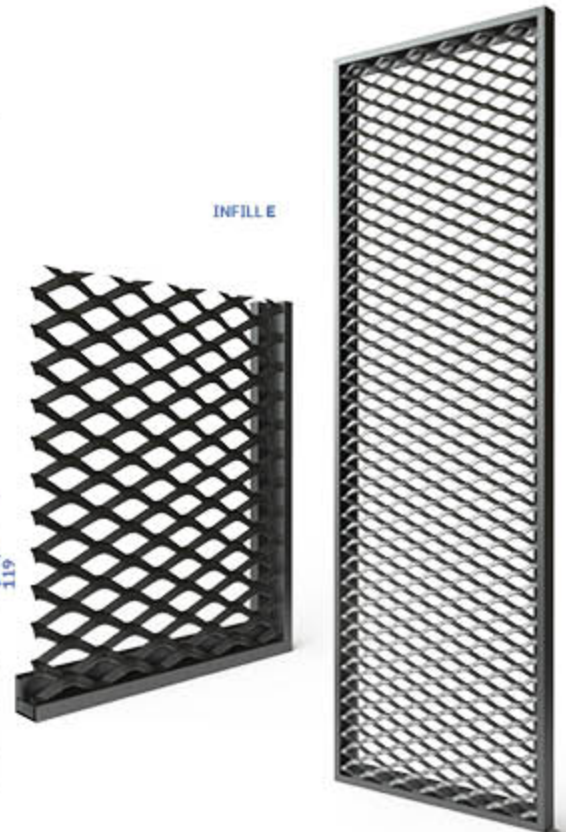
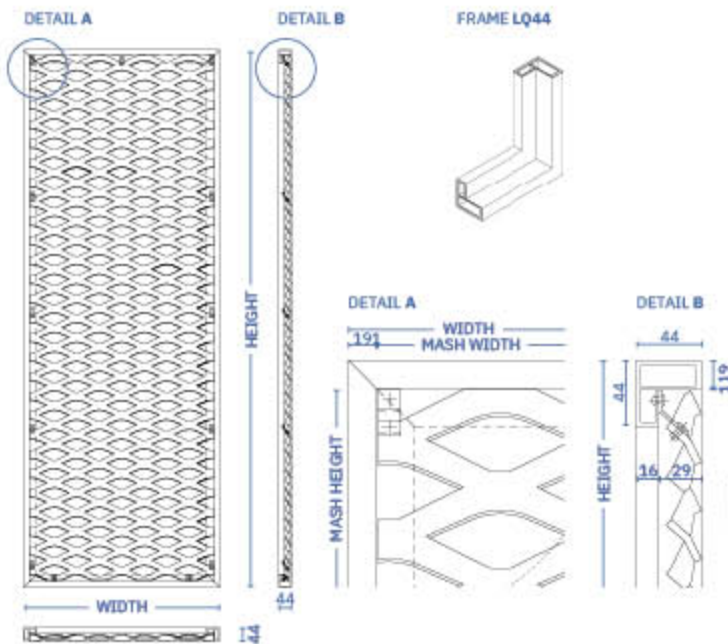

FRAME LQ44

INFILL F: FUNDERMAX EXTERIOR PANEL

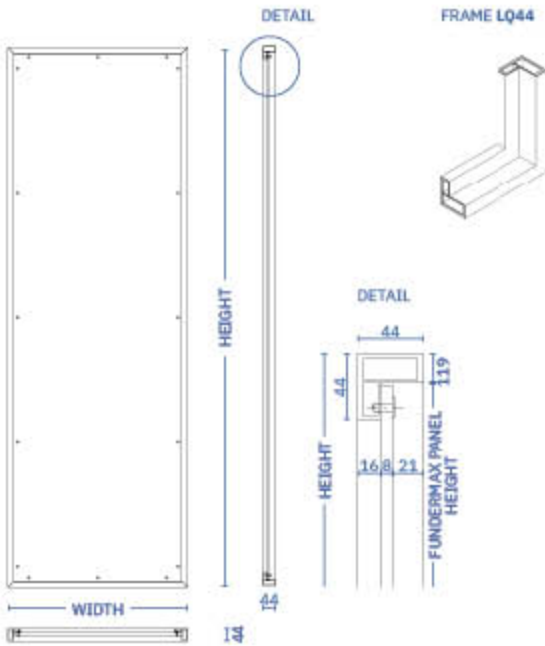

FRAME LQ44

INFILL G: WOOD SLATS 20x70

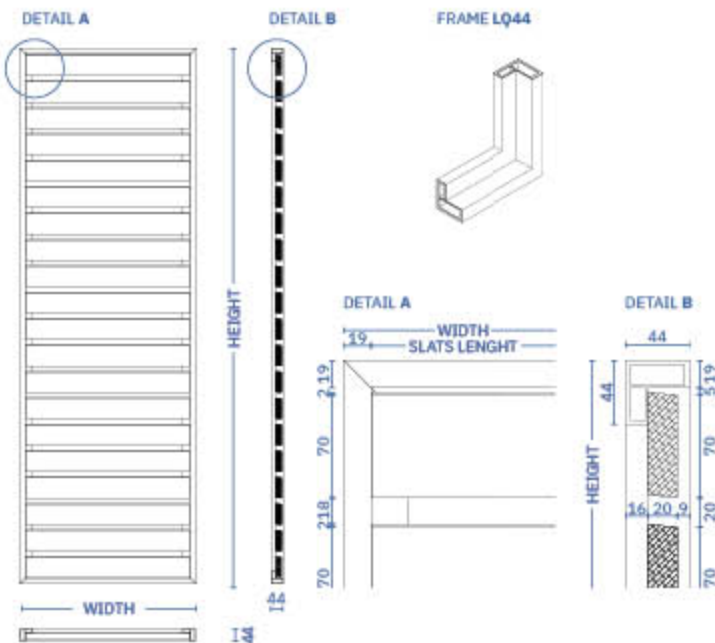

||| || FRAME L 50

| INFILL H: WOOD SLATS 45x45

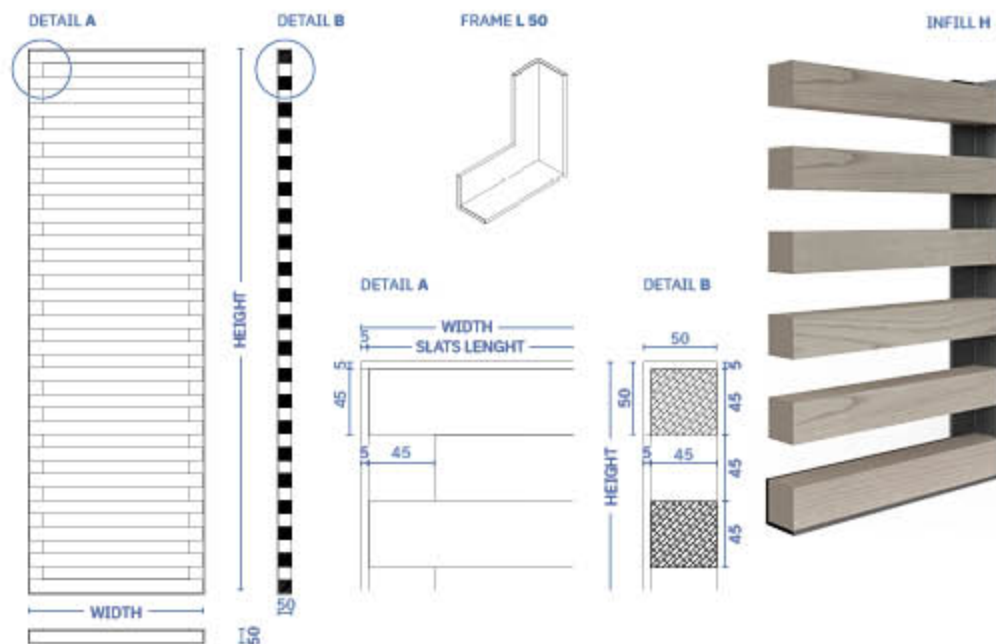

||| || FRAME H 50

| INFILL A: ALUMINIUM SLATS 10x50

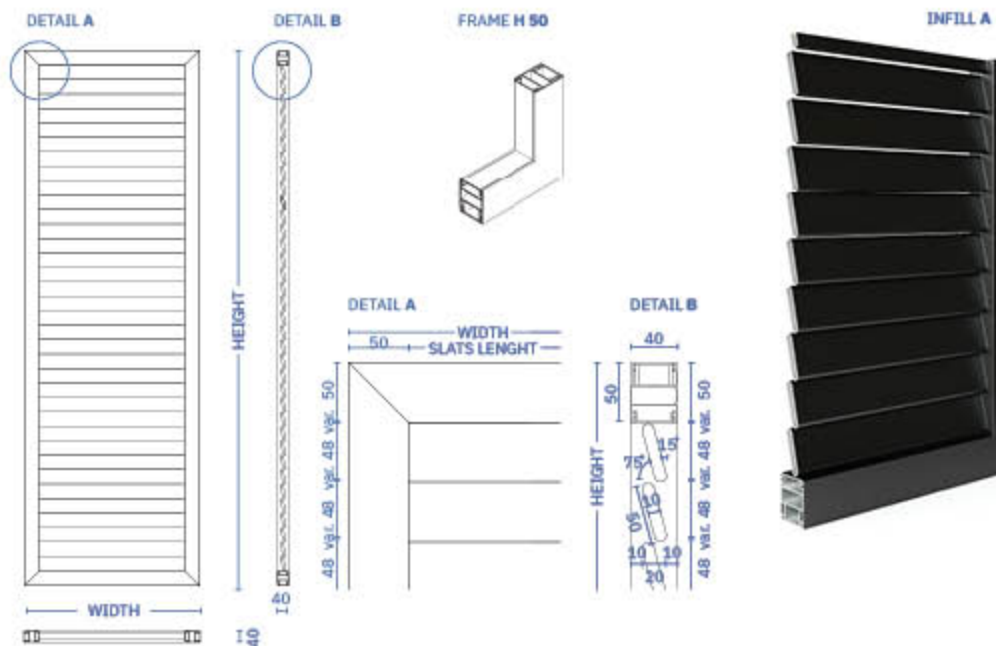



FRAME H 50

INFILL C1: ONE SIDE ALUMINIUM SHEET

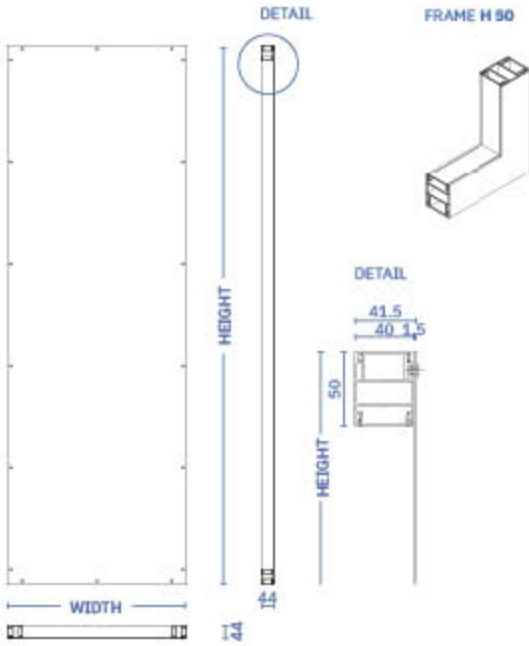

FRAME H 50

INFILL C2: DOUBLE SIDE ALUMINIUM SHEET

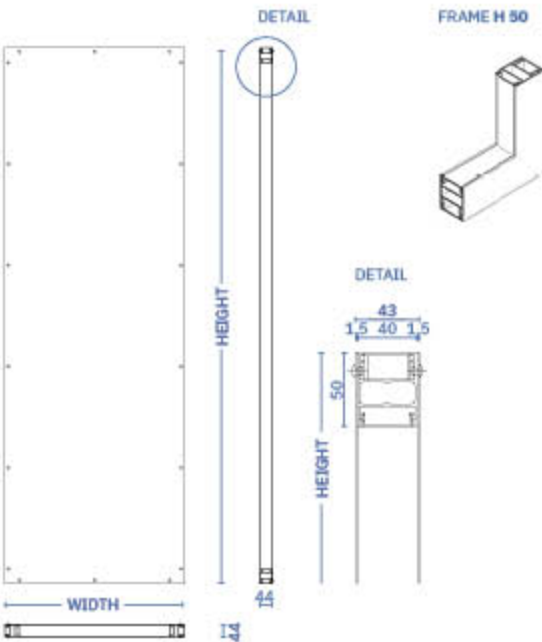

||| || FRAME H 50

INFILL D1: ONE SIDE ALUMINIUM PERFORATED SHEET

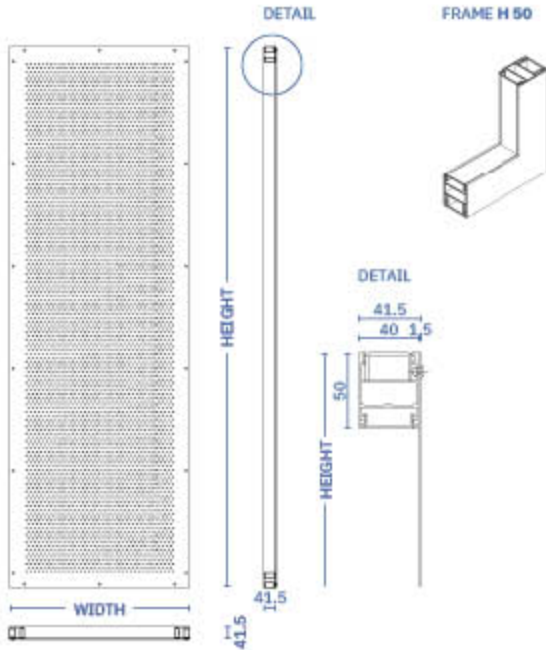

||| || FRAME H 50

INFILL D2: DOUBLE SIDE ALUMINIUM PERFORATED SHEET

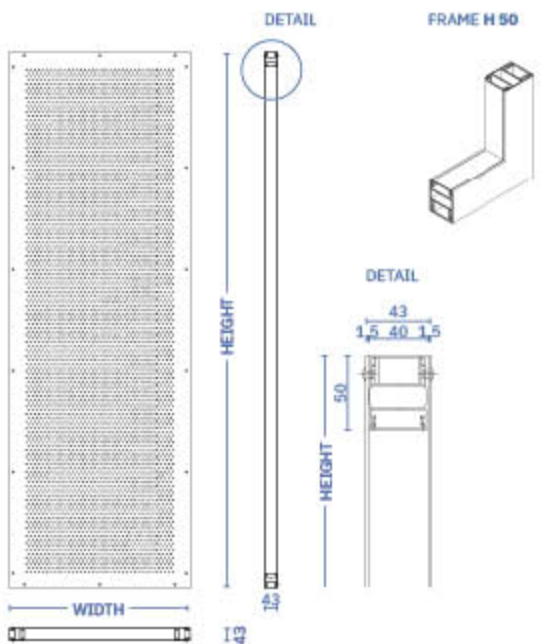

FRAME H 50

INFILL F: FUNDERMAX EXTERIOR PANEL

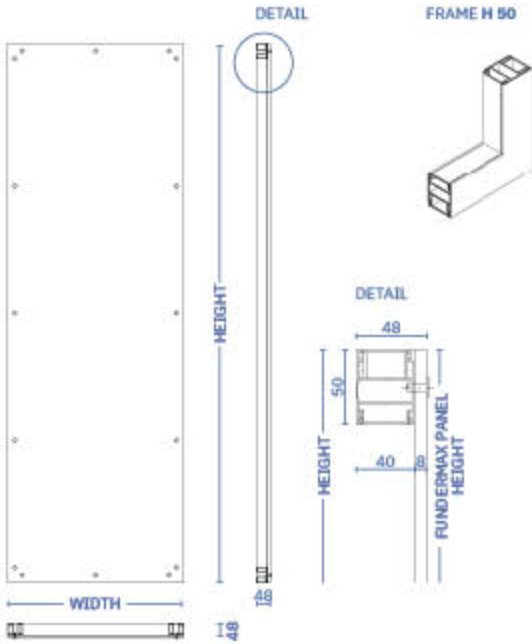

FRAME H 50

INFILL G: WOOD SLATS 20x70

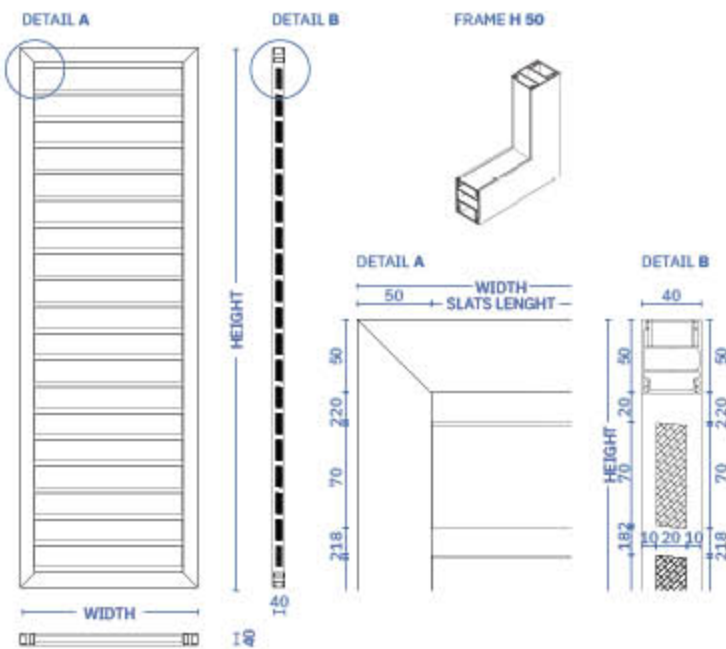

||| || FRAME Q40

INFILL A: ALUMINIUM SLATS 10x50

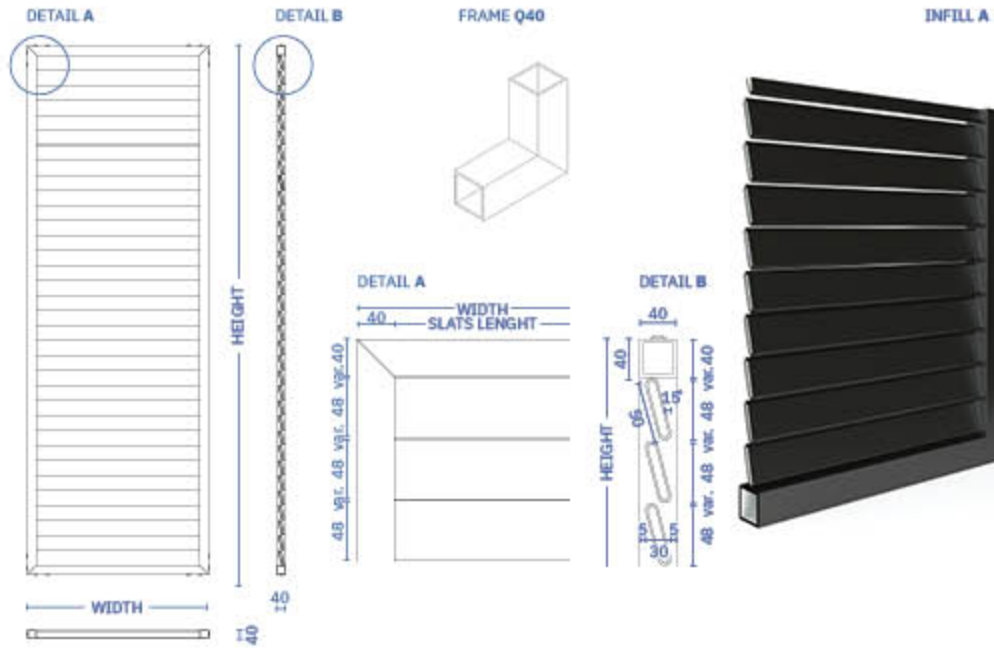

||| || FRAME Q40

INFILL B: ALUMINIUM SLATS 20x20

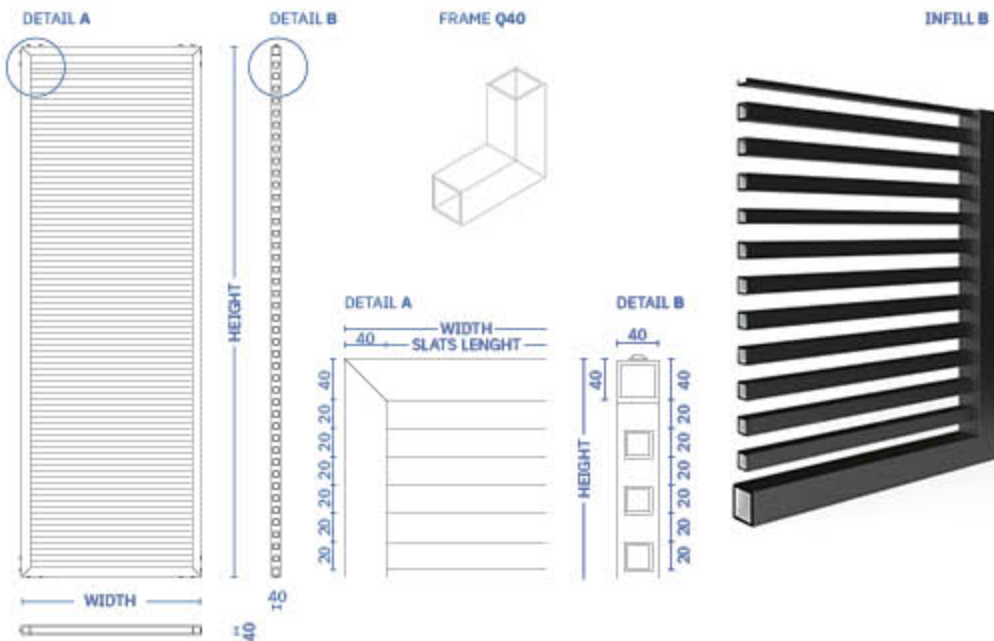

||| || FRAME Q40

INFILL C1: ALUMINIUM SHEET

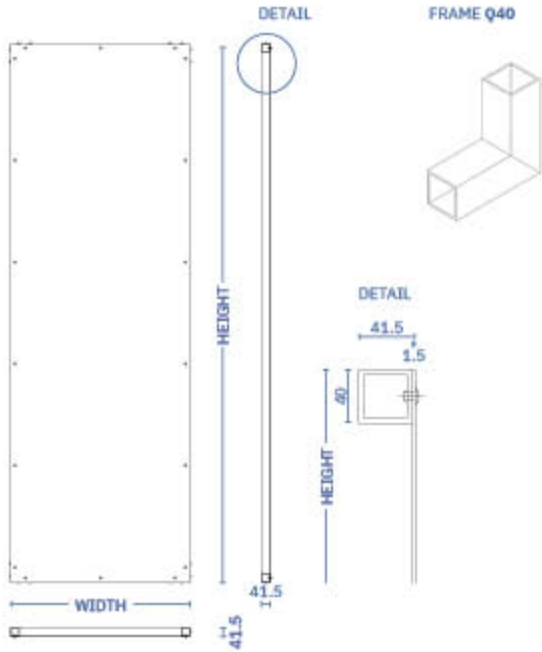

INFILL C1



||| || FRAME Q40

INFILL C2: DOUBLE SIDE ALUMINIUM SHEET

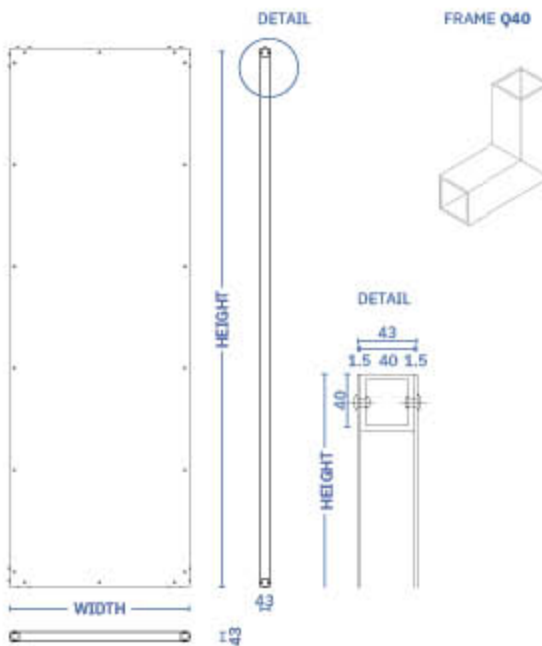

INFILL C2

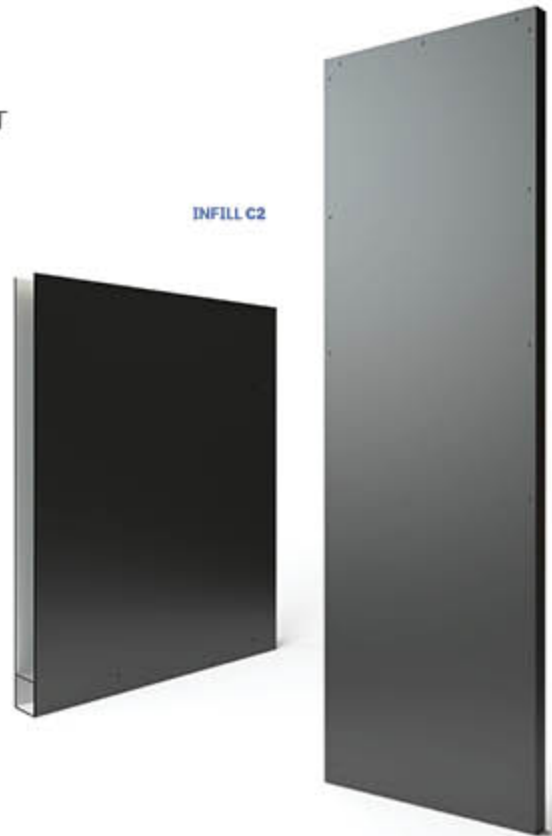

||| || FRAME Q40

INFILL D1: ALUMINIUM PERFORATED SHEET

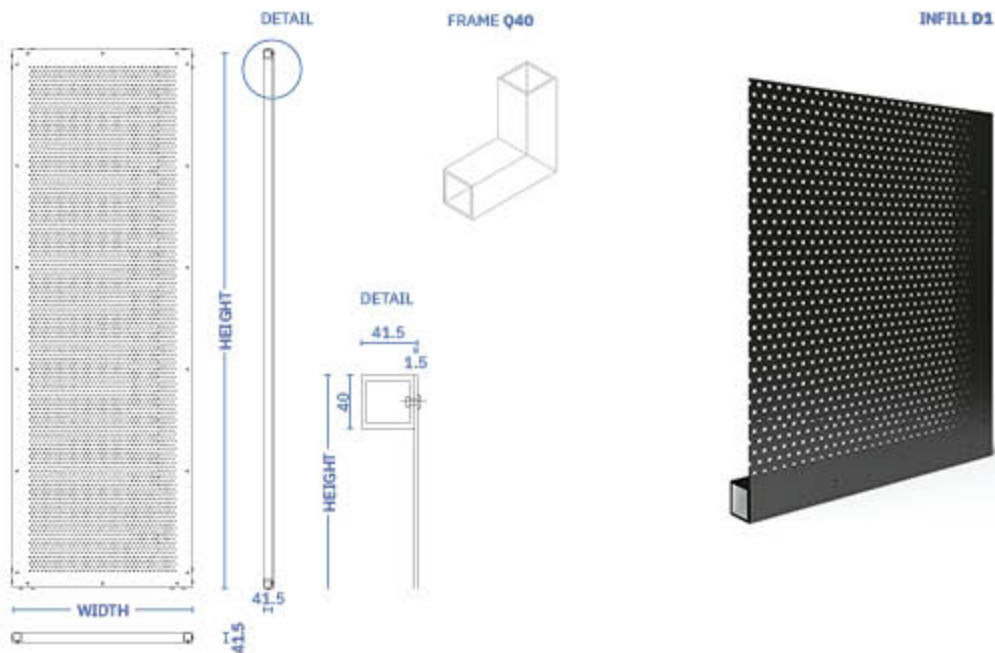

||| || FRAME Q40

INFILL D2: DOUBLE SIDE ALUMINIUM PERFORATED SHEET

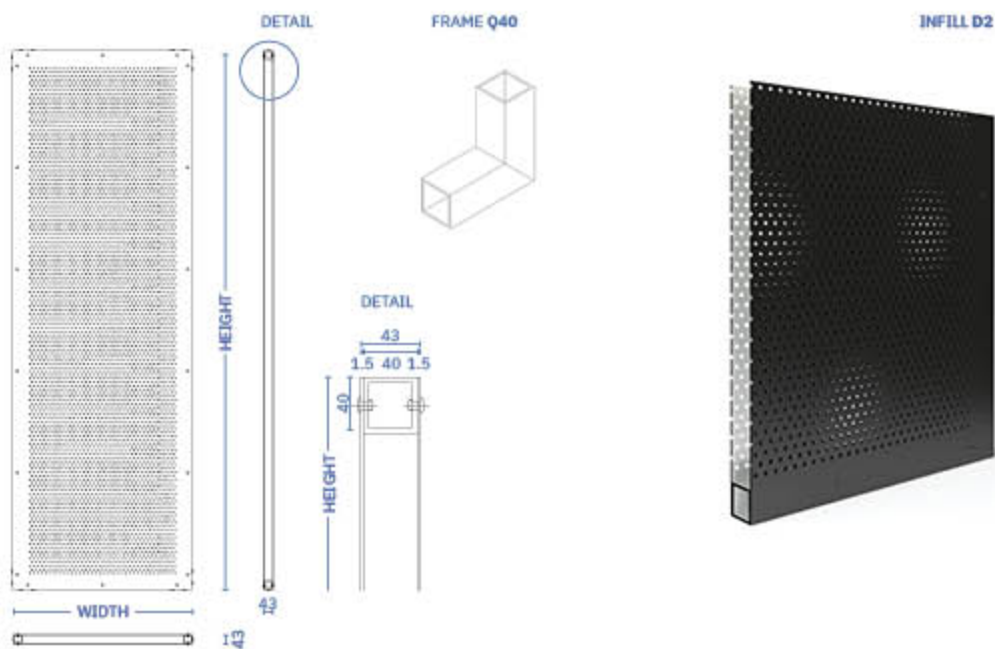

FRAME Q40

INFILL F: FUNDERMAX EXTERIOR PANEL

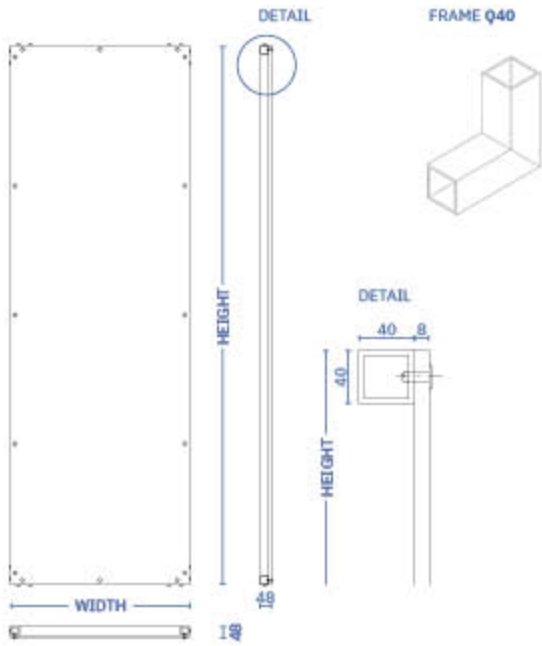

INFILL F



FRAME Q 40

INFILL G: WOOD SLATS 24x70

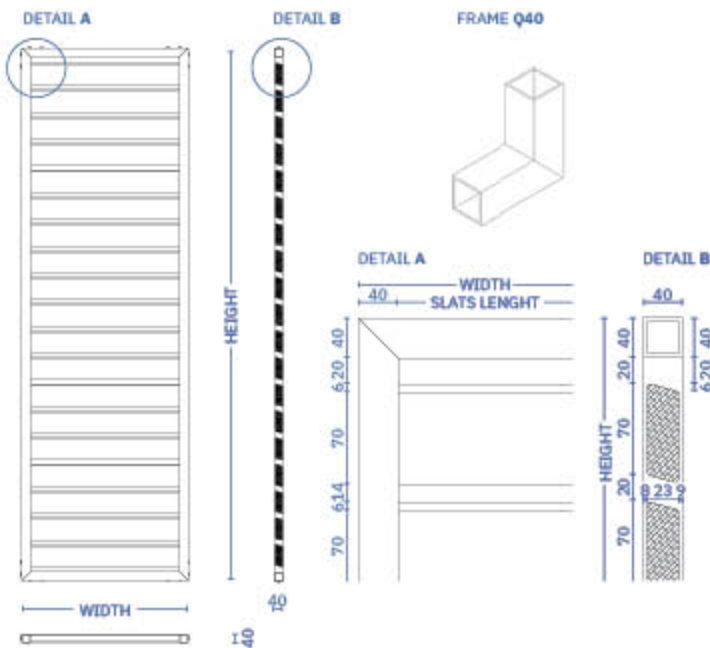

INFILL G





# ACCESSORIES

## HANDLE TYPE A

HANDLE HORIZONTAL SECTION DETAIL

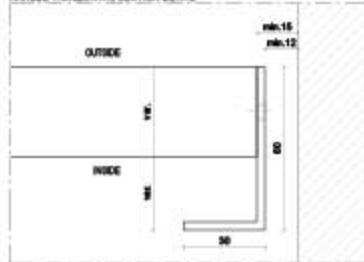

HANDLE ELEVATION VIEW DETAIL FROM INSIDE

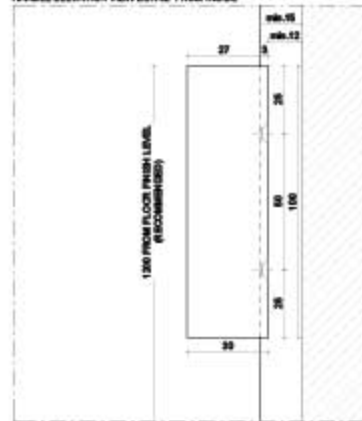

HANDLE ELEVATION SIDE VIEW DETAIL

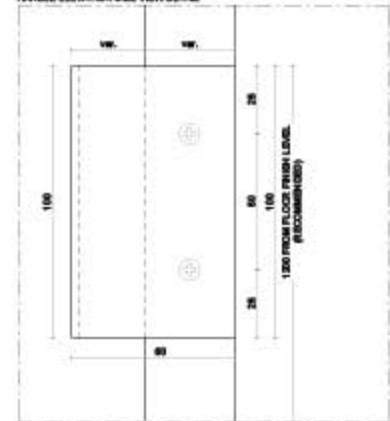





# ACCESSORIES

LOCKER ELEVATION VIEW\_OPTION A  
FOR BOTH SIDE CLOSED PANELS

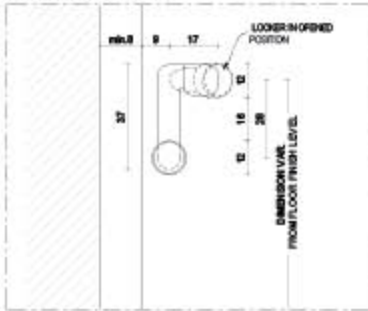

LOCKER ELEVATION VIEW\_OPTION B  
FOR ONE SIDE CLOSED PANELS



LOCKER  
TYPE A

LOCKER HORIZONTAL SECTION VIEW\_OPTION A  
FOR BOTH SIDE CLOSED PANELS

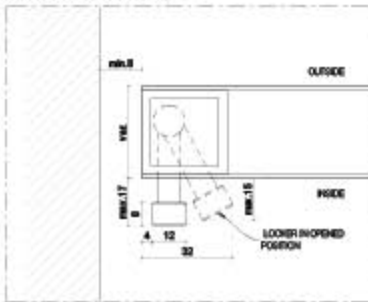

LOCKER HORIZONTAL SECTION VIEW\_OPTION B  
FOR ONE SIDE CLOSED PANELS

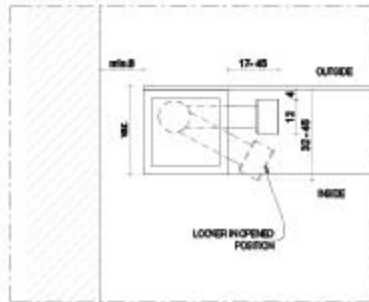

LOCKER SIDE VIEW\_TOP OF PANEL

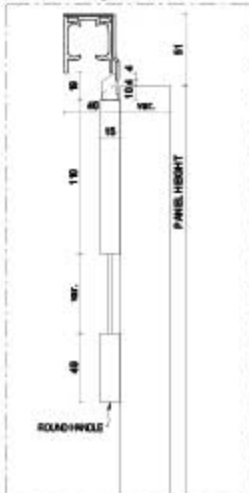

LOCKER ELEVATION INSIDE VIEW\_TOP OF PANEL

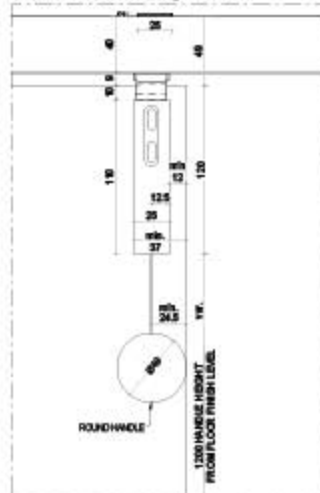

LOCKER  
TYPE B

OPTIONAL LOCKER SIDE VIEW\_BOTTOM OF PANEL

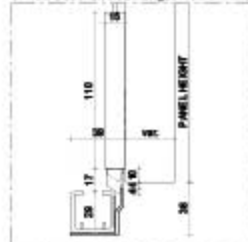

OPTIONAL LOCKER ELEVATION INSIDE VIEW\_BOTTOM OF PANEL



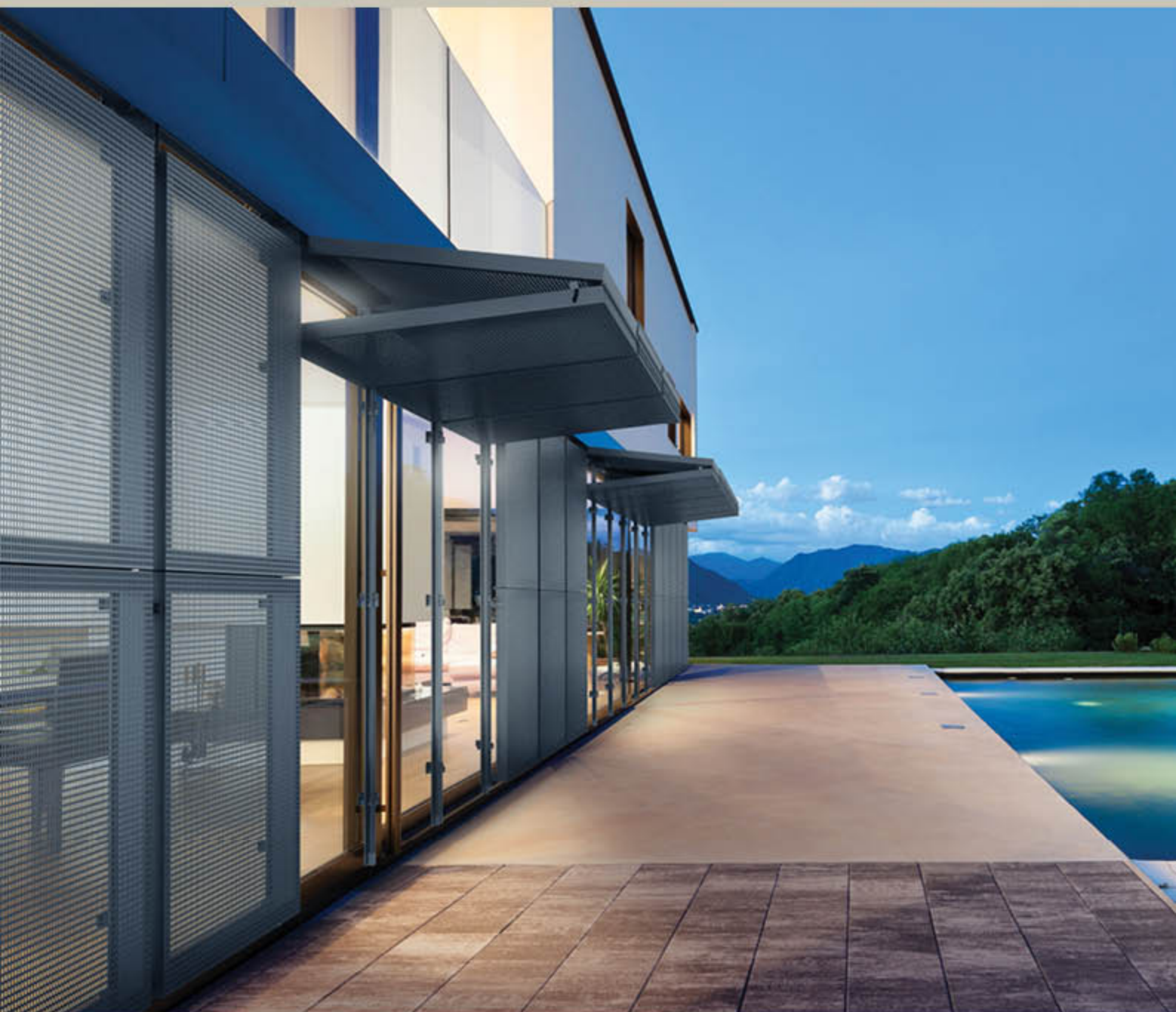



## **STANDARDISED CUSTOMIZATION**

By utilizing standardised components built around a central core, the final products can be created. This approach provides customers with a wide range of options and features for their products, allowing them to customise and configure a unique product that meets their specific needs. Such standardisation ensures consistency and compatibility among different components, making it easier for customers to upgrade or replace parts in the future. But above all, this gives them the opportunity to create something entirely new.









**soltec**  
More life.

**SOLTEC** d.o.o.

Obrtna ulica 9

8257 Dobova

Slovenia, EU

+386 7 45 22 126

+386 51 650 850

[info@soltec.si](mailto:info@soltec.si)

[www.soltec.si](http://www.soltec.si)