



Nüsing Faltina-plan.
Making room division into child's play.



A harmonious use of space

The Folding Wall Faltina-plan from Nüsing is the quick and practical solution for the flexible use of your rooms, in particular, when there is no great need for sound insulation.

This tailor-made concertina door system is comfortable and easy-to-use. Within just a few seconds, you can neatly divide up a room, in a way that naturally blends in with your interior design.

Listen carefully when you open or close the door, what do you hear? Next to nothing! All thanks to a spring mechanism inside the Nüsing Faltina-plan. Sounds like a smooth addition to any room!



Manoeuvrable and quiet – partitioning rooms has never been so easy.



One of the basic essentials – choice!

Why not have the best of both worlds, with the space-saving Nüsing Faltina-plan? When closed, it provides you and your guests with all the comfort and privacy of a separate room.

Or treat your guests to a spacious and open plan design by simply opening the Nüsing Faltina-plan. The choice is yours.

*Variety is the spice of life:
spice it up with a Nüsing Faltina-plan.*



Quality, functionality and comfort.

Individual solutions don't have to be complicated: We produce the Nüsing Faltina-plan made-to-measure, everything from the dimensions to finishes, to cater for your individual needs. Our quality management ensures every Nüsing product achieves the highest quality standards. We set ourselves such high standards to satisfy your every need.

The solid construction gives you peace of mind that we have your safety at heart and no matter how often you move the Nüsing Faltina-plan, it will keep on moving smoothly for years to come.

That's why we offer a 5 year warranty on the product.



As safe as could be and as easy as ABC. The Nüsing Faltina-plan is a real treat to use.

The secret to the Nüsing Folding Wall Faltina-plan is in the detail.

Fixed wall post

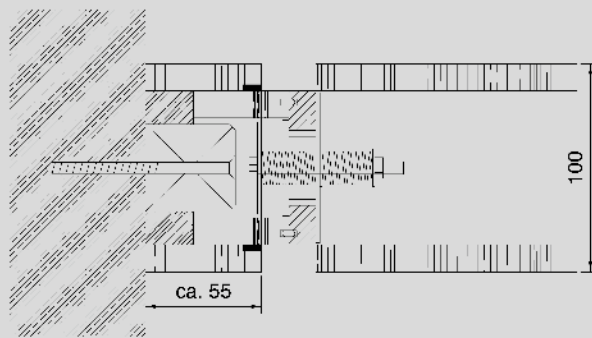

Wall post 1 wing

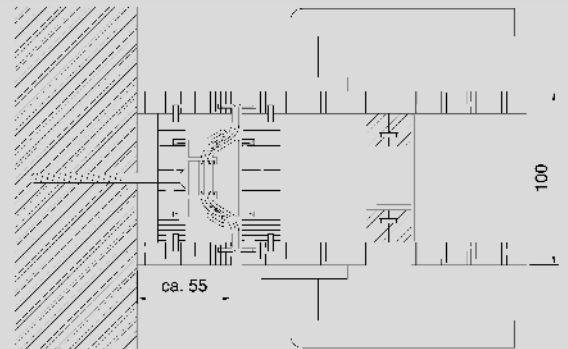

Track cladding

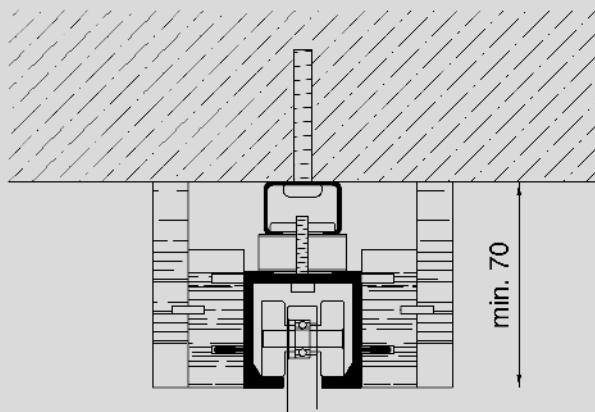

Block track cladding

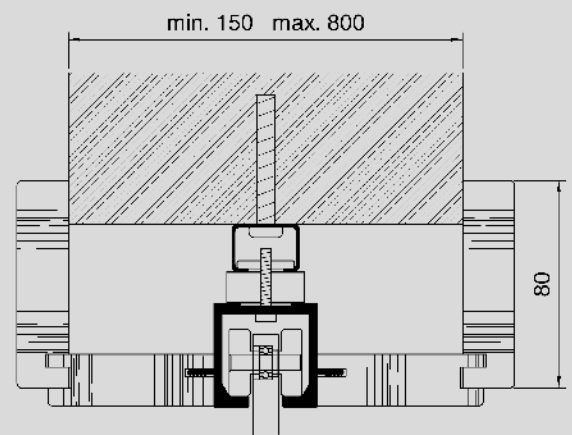

Suspension

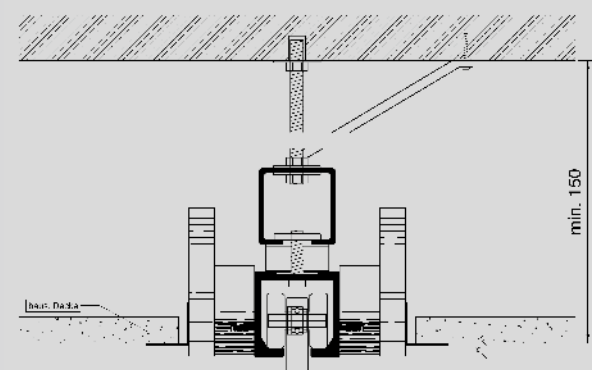



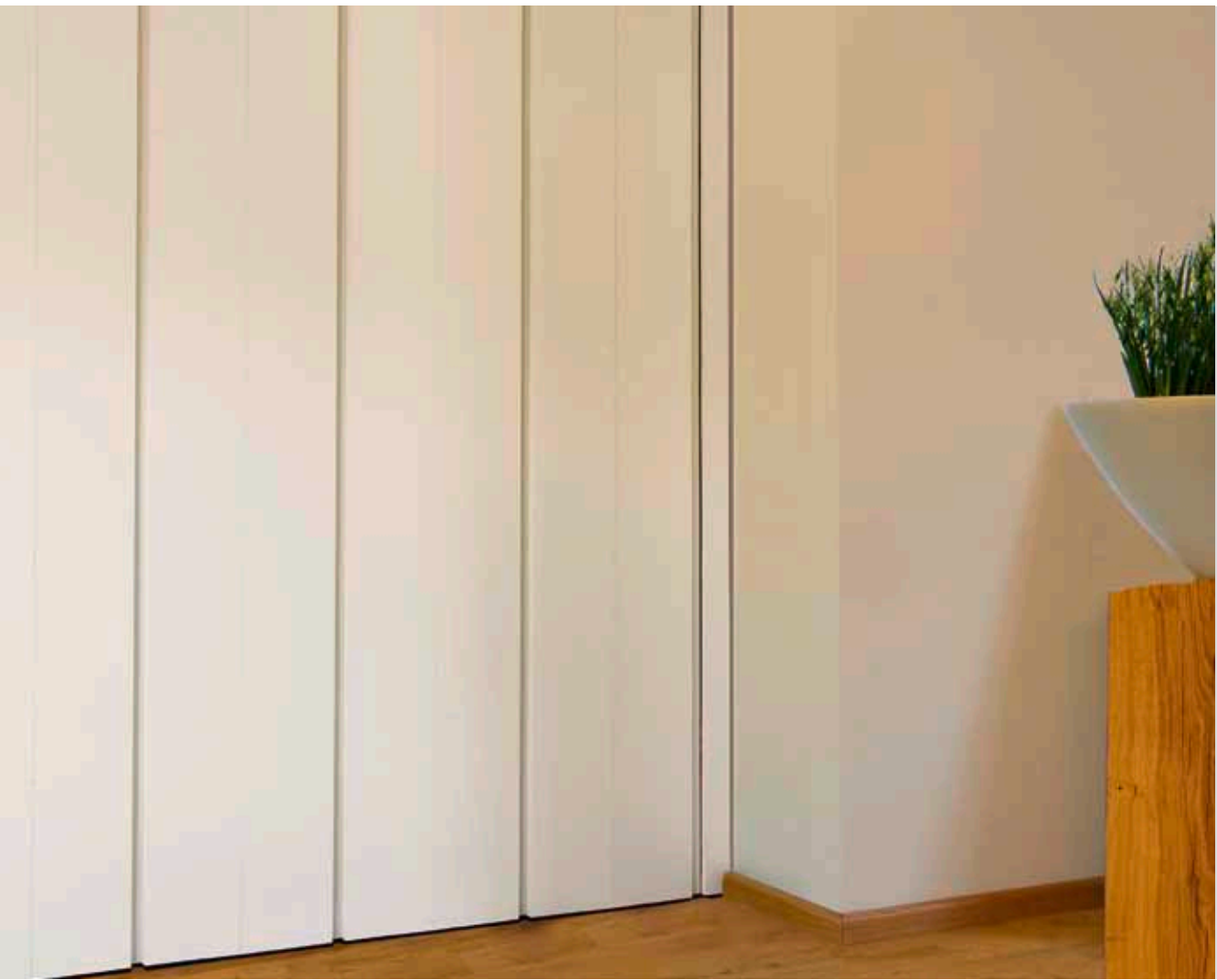

Finishes

alabaster
RAL 1013

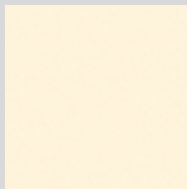

bavaria beech

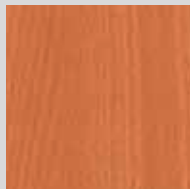

ellmau beech



maple

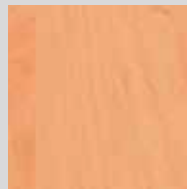

light grey
RAL 7035

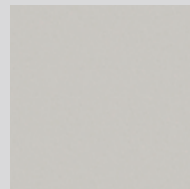

pastel yellow

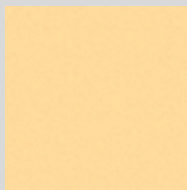

white
RAL 9016

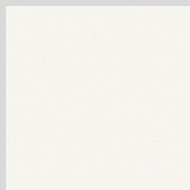

white grey

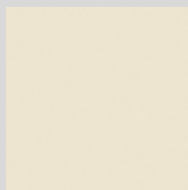

Due to printing reasons, small differences can occur from the actual product.



Franz Nüsing GmbH & Co. KG
Borkstraße 5
48163 Münster
Germany
Telephone +49 (0)251 780010
Fax +49 (0)251 7800127
+49 (0)251 7800145
E-Mail info@nuesing.com
www.nuesing.com