





# Dual StarWhite

I  
Evoluzione dell'ombrellone singolo Astro. Adatto per tutti gli ambienti. Telaio in alluminio con verniciatura bianco Starwhite opaco, unico nel suo genere. Struttura robusta composta da 2 ombrelloni ancorati ad un unico sostegno. Soluzione studiata per ampie superfici. Apertura e chiusura retrattile con molla gas al di sopra di tavoli e sedie senza dover spostare gli arredi.

EN  
Evolution of the single parasol Astro. Suitable for all environments. Aluminium frame epoxy coated matt Starwhite. Strong structure composed of 2 parasols anchored to a single support. Solution designed for large surfaces. Retractable opening and closing above tables and chairs without moving the furniture provided by gas spring.

D  
Entwicklung des Modells Astro. Geeignet fuer alle Bereiche. Aluminiumgestell pulverbeschichtet Mattweiss Starwhite. Starkes Gestell mit 2 Sonnenschirmen, die an einem Mast befestigt sind. Fuer grosse Flaechen geeignet. Einziehbares Oeffnen und Schliessen mit Gasfeder oberhalb von Tischen und Stuehlen.

F  
Evolution du parasol Astro. Pour tous les environnements. Armature en aluminium vernis blanc Starwhite, unique en son genre. Structure robuste composée de 2 parasols ancrés à un seul support. Solutions conçue pour les grandes surfaces. Ouverture et fermeture avec ressort à gaz au-dessus des tables et des chaises sans déplacer les meubles.

E  
Evolución del parasol único Astro. Para todos los ambientes. Marco de aluminio pintura blanca Starwhite mate, único en su clase. Estructura robusta compuesta por 2 parasoles anclados a un solo soporte. Solución diseñada para grandes superficies. Apertura y cierre retráctil con muelle de gas sobre mesas y sillas sin mover los muebles.





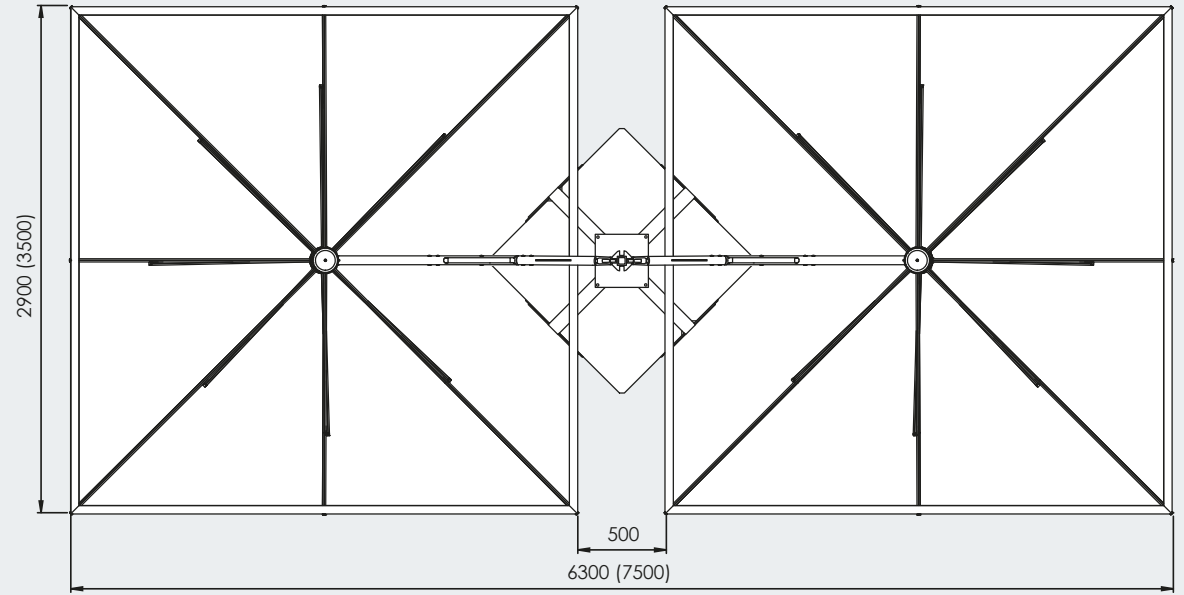









300x600  
350x700



# Dual-T

Timber  
Carbon  
StarWhite

		COD	KG			CHARACTERISTICS				FINISHING					
															INOX
3,0x6,0		TIMBER C3060 DTL	120	0,45	110x110	TIMBER	8	TIMBER	18x30	●	●	●	●	●	●
		STARWHITE C3060 DTW				STARWHITE		STARWHITE							
		CARBON C3060 DTC				CARBON		CARBON							
3,5x7,0		TIMBER C3570 DTL	125	0,45	110x110	TIMBER	8	TIMBER	18x30	●	●	●	●	●	●
		STARWHITE C3570 DTW				STARWHITE		STARWHITE							
		CARBON C3570 DTC				CARBON		CARBON							

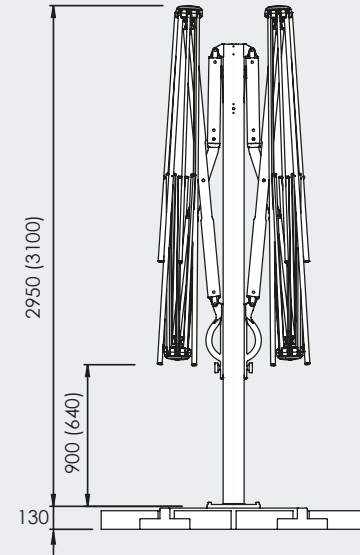
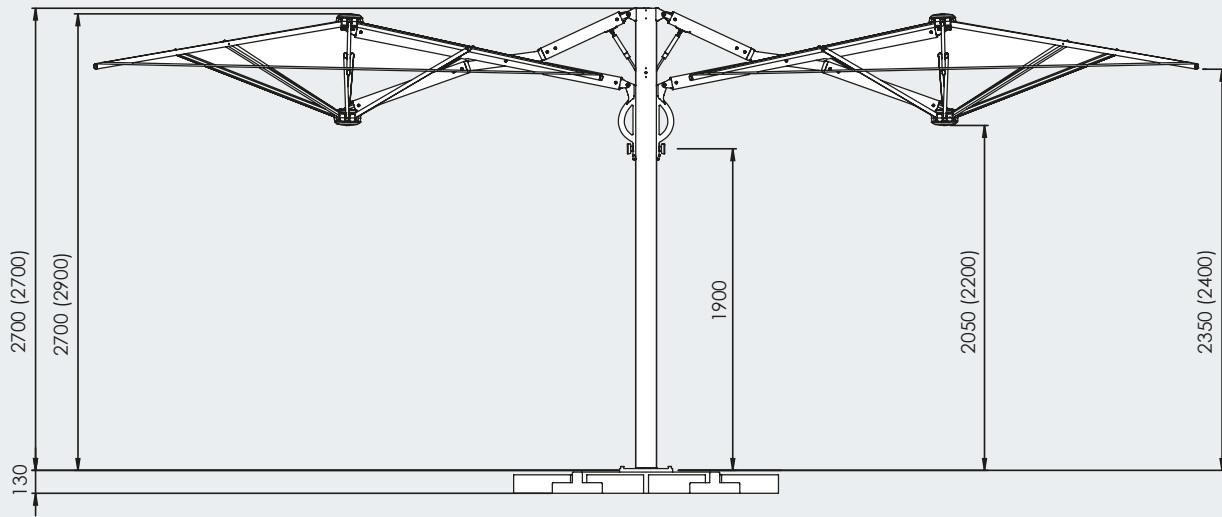

**OPTIONAL**

N°4 BC5151  
N°12 BC5050

N°4 BV5050

SEE PAGE 34

FISSAGGIO TERRA  
GROUND FIXING

# Fabric collection



## FATTORE DI PROTEZIONE SOLARE

Limita il passaggio del calore per più del 70%.  
Normativa UNI EN 410:2011

## SOLAR PROTECTION FACTOR

Harmful UV rays and limiting heat circulation  
Norm UNI EN 410:2011



## FATTORE DI PROTEZIONE LUMINOSA

Indica la percentuale di trasmissione della luce  
Normativa UNI EN 410:2011

## FACTOR OF SOLAR LIGHT PROTECTION

% of light transmission  
Norm UNI EN 410:2011



## FATTORE DI PROTEZIONE UPF

Protezione dai raggi UV. (UPF) dal 85% al 100%  
Normativa UNI EN 13758-1:2007

## UPF PROTECTION FACTOR











Harmful UV rays. (UPF) from 85% almost 100%  
Norm UNI EN 13758-1:2007

## SCHEDA TECNICA / DATA SHEET

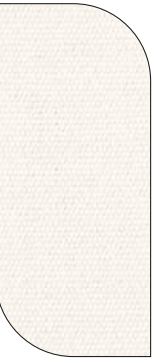
COMPOSIZIONE / COMPOSITION	CARATTERISTICHE / FINISHING	SOLIDITÀ AL COLORE / COLOR FASTNESS	TRATTAMENTO / TREATMENT	IMPERMEABILITÀ / COLONNA D'ACQUA IMPERMEABILITY / WATER COLUMN
350 gr/m2 100% ACRYL	Inattaccabile da muffe e batteri. Solido alla luce Permeabile all'aria Antimacchia	GRADO 7/8 ENSIO 105-B04	RESINE TEFLON IDRO-OLEOREPELLENZA	CIRCA 25 CM
350 gr/m2 100% ACRYL	Resistant to mold and bacteria. Color fast. Breathable. Stain REPELLENT.	GRADE 7/8 ENSIO 105-B04	TEFLON RESIN WATER-OILREPELLENCY	ABOUT 25 CM



# Fabric collection

								
<b>350</b> <b>GR/M<sup>2</sup></b> <b>ACRYLIC</b>	<b>A1</b> ECRU NATURAL COL. NATUR	<b>T2</b> TERRACOTTA ZIEGELROT TERRACOTTA	<b>T3</b> BORDEAUX	<b>T6</b> GRIGIO TAUPE GREY TAUPE GRAU TAUPE GRIS TAUPE GRIJS TAUPE	<b>T7</b> BIANCO WHITE BLANC WEISS	<b>T8</b> GRIGIO PERLA SILVER GREY SILBERGRAU	<b>T9</b> GRIGIO ANTRACITE ANTHRACIT GREY ANTHRACITGRAU	<b>S1</b> NERO / BLACK SCHWARZ NOIRE NEGRO ZWART
	70/80%	> 90%	> 90%	> 90%	70/80%	> 90%	> 90%	> 90%
	20/30%	< 10%	< 10%	< 10%	20/30%	< 10%	< 10%	< 10%
	85/89%	100%	100%	100%	85/89%	100%	100%	100%

I dati forniti, pur essendo frutto di misurazioni scientifiche condotte in laboratori certificati, sono da ritenersi indicativi.  
The above mentioned data are indicative, although provided by scientific measurements performed in certified laboratories.



.Dimensione (metri)  
 .Dimensions (meters)  
 .Masse (Meter)  
 .Dimensions (metrès)  
 .Dimensiones ( en metros)  
 .Afmeting in (meters)



.Stecche  
 .Ribs  
 .Streben  
 .Baleines  
 .Varillas  
 .Baleinen



.Sistema retrattile  
 .Retractile system  
 .Einziehbares System  
 .Système retractile  
 .Sistema retráctil  
 .Inklapbaar systeem



.Massima Stabilità Ottenibile  
 .Maximum Obtainable Stability  
 .Maximal Erhaeltliche Stabilitaet  
 .Maximum De Stabilitée Realisable  
 .Maxima Estabilidad Posible  
 .Maximaal Bereikbare Stabilitée



.Codice  
 .Code  
 .Artikelcode  
 .Code  
 .Código  
 .Artikelcode



.Set canaline  
 .Raugutter set  
 .Regrinnen  
 .Set gouttières  
 .Canalizador Lluvias  
 .Set regengoten



.Piastre cemento  
 .Cement slabs  
 .Kiesbetonplatten  
 .Dalles ciment  
 .Planchas de cemento  
 .Betontegel



.Peso consigliato in condizioni normali  
 .Recommended weight in normal condition  
 .Empfohlenes gewicht unter normalen bedingungen  
 .Poids recommande dans des conditions normales  
 .Peso recomendado en condiciones normales  
 .Aanbevolen gewicht onder normale omstandigheden



.Lunghezza  
 .Length  
 .Laenge  
 .Longueur  
 .Longitud  
 .Lengte



.Con base/supporto  
 .With base/support  
 .Mit Staender/Huelse  
 .Avec base/support  
 .Con base/ soporte  
 .Inclusief standaard



.Stecca con sistema "easy change"  
 .Ribs with "easy change" system  
 .Streben mit "easy change" System  
 .Baleines avec "easy change" système  
 .Varillas con sistema de " cambio fácil"  
 .Baleinen met het "easy change" systeem



.Peso minimo richiesto  
 .Minimum ballast required  
 .Erforderliches mindestgewicht  
 .Poids minimum requis  
 .Peso minimo requerido  
 .Minimaal vereist gewicht



.Peso  
 .Weight  
 .Gewicht  
 .Poids  
 .Peso  
 .Gewicht



.Sezione stecche  
 .Rib section  
 .Strebenprofil  
 .Section baleines  
 .Sección varillas  
 .Profil baleinen



.Viteria in inox e ottone nichelato  
 .Screws in Stainless steel and nickel plated brass  
 .Edelstahlschrauben und vernickeltes Messing  
 .Visserie inox et laiton nickelé  
 .Tornillos en acero inoxidable y bronce niquelado  
 .Schroeven van rvs en vernikkeld messing



.Volume (m³)  
 .Volume (m³)  
 .Volumen (m³)  
 .Volume (m³)  
 .Volumen (m³)  
 .Volume (m³)



.Camino antivento  
 .Wind cap  
 .Windfang  
 .Souffle  
 .Chimenea antiviento  
 .Windvang



.Tipo finitura della struttura/sostegno/componenti  
 .Finishing for frame/structure/components  
 .Ausfuehrung des Gestells/der Struktur/der Bestandteile  
 .Finition armature/structure/composants  
 .Tipo de acabado de la estructura/Soportes/componente



.Sezione sostegno (mm)  
 .Support section (mm)  
 .Mastprofil (mm)  
 .Section support (mm)  
 .Sección soporte (mm)  
 .Mast (mm)



.Fodero  
 .Cover bag  
 .Schutzhuelle  
 .Housse  
 .Forro  
 .Afdekhoes



.Colore dei componenti/stecche  
 .Component/Ribs colour  
 .Farbe der Bestandteile und Streben  
 .Couleur des composants et baleines  
 .Color de los componentes ò piezas/Varillas ò listones