NON-SELF-SUPPORTING PROFILE SYSTEMS

PERGOLUX

Profiles for a timber supporting structure

Any construction with multi-walled plastic sheets requires non-self-supporting aluminium profiles. These profiles must be mounted on timber or steel rafters before fixing the sheets into them. The multi-walled sheets are not screwed. Heat can cause the multi-walled plastics sheets to expand and can cause cracks. The aluminium profiles allow the sheets to move enough to prevent these cracks. We offer different types of profiles to click or to drill in plastic material or in aluminium. The choice is yours!





The Pergolux D Series can be assembled with “shim tape” or as a full set. Thanks to the high-quality profiles, your conservatory roof will have an elegant design.

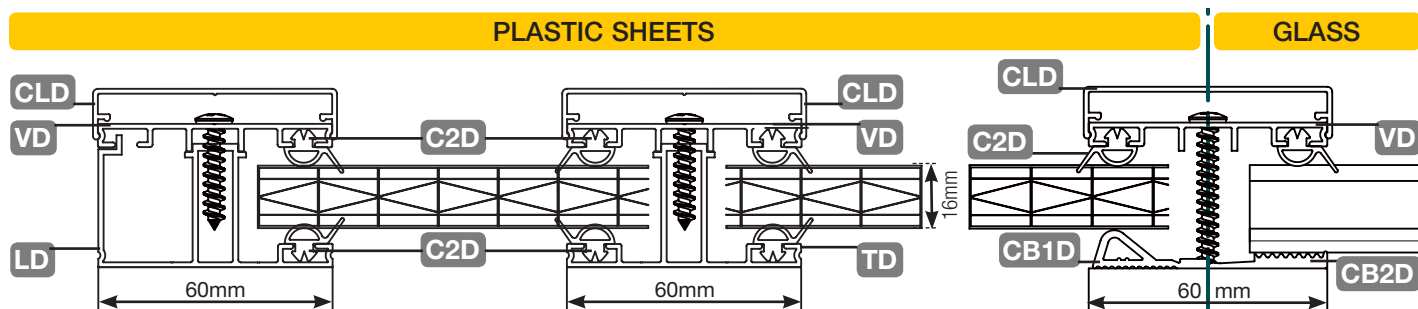

Price list Pergolux D-series





GROUP	TYPE	DESCRIPTION	LENGTH	ARTICLE	UNIT	PRICE / UNIT
WALL PROFILE			M	0	W	0 W
	MD	Wall profile (122mm width)	4.1	25125	m	€ 9.86
			5.1	25649	m	€ 9.86
			6.1	25126	m	€ 9.86
			7.1	25650	m	€ 9.86



GROUP	TYPE	DESCRIPTION	LENGTH	ARTICLE	UNIT	PRICE / UNIT		
RAFTER AND SIDE RAFTER			M	0	W	0 W		
	TD	Rafter TD	2.5	30348	m	€ 8.23		
			3	29457	m	€ 8.23		
			3.5	29458	m	€ 8.23		
			4	25101	m	€ 8.23		
			5	25102	m	€ 8.23		
			6	25103	m	€ 8.23		
			7	25104	m	€ 8.23		
	LD	Side rafter LD	2.5	30347	m	€ 8.85		
			3	29455	m	€ 8.85		
			3.5	29456	m	€ 8.85		
			4	25105	m	€ 8.85		
			5	25106	m	€ 8.85		
			6	25107	m	€ 8.85		
			7	25108	m	€ 8.85		
	VD	Connecting profile VD	2.5	32327	m	€ 4.85		
			3	29459	m	€ 4.85		
			3.5	29460	m	€ 4.85		
			4	25097	m	€ 4.85		
			5	25098	m	€ 4.85		
			6	25099	m	€ 4.85		
			7	25100	m	€ 4.85		
	CLD	Clip cover for rafter and side rafter	4	25113	25121*	m	€ 4.12	€ 6.38
			5	25114	25122*	m	€ 4.12	€ 6.38
			6	25115	25123*	m	€ 4.12	€ 6.38
			7	25120	25124*	m	€ 4.12	€ 6.38
	Y16D	Filling profile for rafter TD	3	44709		m	€ 3.96	
			3.5	44710		m	€ 3.96	
			4	44711		m	€ 3.96	
			7	44712		m	€ 3.96	

FINISH

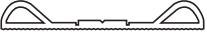
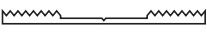
0 = mill finished aluminium / W = white or RAL 9010
 * Delivery time on request

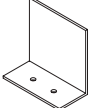
GROUP	TYPE	DESCRIPTION	LENGTH	ARTICLE		UNIT	PRICE / UNIT	
RUBBER			M	0	W		0	W
	C1D	Sealing for wall profile coex white	100 *		25130	m		€ 2.61
	C2D	Sealing for wall profile coex white for DT, DL and DV	200 *		25131	m		€ 1.36
	CB1D	Soft rubber strip coex white	50 *		25133	m		€ 3.96
	CB2D	Ribbed inferior strip - black	50 *	25134		m	€ 2.72	

GROUP	TYPE	DESCRIPTION	LENGTH	ARTICLE		UNIT	PRICE / UNIT	
STOP				0			0	
	SD	L-shaped stop for aluminium profiles	pc	46546		pc	€ 2.44	

GROUP	TYPE	DESCRIPTION	LENGTH	ARTICLE		UNIT	PRICE / UNIT	
PROFILES WITH PRE-MOUNTED RUBBER			M	0	W		0	W
	ETD	Rafter TD with 2 x rubber C2D	2.5	32329		m	€ 11.74	
			3	29591		m	€ 11.74	
			3.5	29592		m	€ 11.74	
			4	25138		m	€ 11.74	
			5	25171		m	€ 11.74	
			6	25172		m	€ 11.74	
			7	25173		m	€ 11.74	
	ELD	Side rafter LD with rubber C2D	2.5	32331		m	€ 10.61	
			3	29593		m	€ 10.61	
			3.5	29594		m	€ 10.61	
			4	25174		m	€ 10.61	
			5	25175		m	€ 10.61	
			6	25176		m	€ 10.61	
			7	25177		m	€ 10.61	
	EVD	Connecting profile VD with 2 x rubber C2D	2.5	32333		m	€ 8.37	
			3	32334		m	€ 8.37	
			3.5	32335		m	€ 8.37	
			4	32336		m	€ 8.37	
			5	32338		m	€ 8.37	
			6	32339		m	€ 8.37	
			7	32340		m	€ 8.37	

FINISH 0 = mill finished aluminium or rubber black / W = white or RAL 9010
 * Length per roll, the rubbers are available in multiple profile lengths

Standard series

<p>ALU</p>	<p>ALU: System with aluminium profiles and standard grey coex rubber</p>	
<p>COLOR</p>	<p>COLOR: System with powder coated aluminium profiles (white RAL 9010 and brown RAL 8019) and white coex rubber</p>	
<p>THERM</p>	<p>THERM: System with thermal break and white coextruded PVC clip</p>	
<p>COLOR-THERM</p>	<p>COLOR-THERM: System with thermal break and powder coated aluminium clip (white RAL 9010, anthracite RAL 7016 ST and brown RAL 8019)</p>	
<p>COLOR-THERM GLASS</p>	<p>COLOR-THERM GLASS: System with thermal break and screwable aluminium clip (white RAL 9010, anthracite RAL 7016 ST, brown RAL 8019 or any other RAL colour of your choice)</p>	

CA = sheet width + 22mm

	WALL	RAFTER	SIDE RAFTER	GUTTER	ACCESSORIES					
16mm	M16 + C4CX 	T16.1 + C2CX + C3 (x2) 	L16 + C3 + C4CX 	G120A + G120AS + C6 	S16C	BT16	BB16	U16P	BM	ALU
32mm	M32T + M32B + C4CX 	T32.1 + C2CX + C3 (x2) 	L32.1 + C4CX + C3 	G120A + G120AS + C6 	S32C	BT32	BB32	U32P	BM	
16mm	M16 + C4CX 	T16.2 + C2CX + C3 (x2) 	LT16 + C3 + C2CX 	G120A + G120AS + C6 	S16C	BT16	BB16	U16	BM	COLOR
32mm	M32T + M32B + C4CX 	T32.1 + C2CX + C3 (x2) 	LT32 + C2CX + C3 	G120A + G120AS + C6 	S32C	BT32	BB32	U32A	BM	
16mm	CLM + MP + C1CX + C12 	T16P + CLPV 	L16P + T16P + CLPV 	G120A + G120AS + C6 	S16.3	BT16	BB16	U16P		THERM
32mm	CLM + MP + C1CX + C12 	T16P + Y32 + CLPV 	L16P + Y32 + T16P + CLPV 	G120A + G120AS + C6 	S32.3	BT32	BB32	U32P		
16mm	CLM + MP + C1CX + C12 	T16P + CL16 + C8 (x2) 	CLL + LP + C8 	G120A + G120AS + C6 	S16.3	BT16	BB16	U16		COLOR-THERM
32mm	CLM + MP + C1CX + C12 	T16P + CL32 + C8 (x2) 	CLL + LP + C8 	G120A + G120AS + C6 	S32.3	BT32	BB32	U32		
8mm to 34mm	CLM + MP + C1CX + C12 + C31 	TPH + TPG + CLSB + CLST + C8 (x2) + screw 	TPHL + TPGL + CLSB + CLSL + C31 + C8 + screw 	G + GAS1 + C13 + C6 	S38.3	L432	Y16P	C11CX		COLOR-THERM GLASS

* to combine with gutter top piece GR

Price list Pergolux

1. Profiles

GROUP	TYPE	DESCRIPTION	LENGTH	ARTICLE NUMBER			UN.	PRICE / UNIT		
M	WALL PROFILES		M	O	W 9010	B 8019	RAL	O	W/B	
	MP	PVC wall profile with soft supporting lips for sheets 16, 25 en 32mm for use with CLM profile	3.5		17756	17689		m	-	€ 8.71
			5		17757	17754		m		
			7		17758	17755		m		
	M16	Alu wall profile without lip for 16mm sheets	3.5	13257	15468	15465		m	€ 10.01	€ 11.42
			5	13258	15469	15466		m		
			7	13259	15470	15467		m		
	M32T	Alu wall profile "top" for sheets > 20mm	3.5	13268	13501	13504		m	€ 9.00	€ 10.85
			5	13269	13502	13505		m		
			7	13270	13503	13506		m		
	M32B	Alu wall profile "bottom" for sheets > 20mm	3.5	13277				m	€ 5.99	-
			5	13280				m		
			7	13281				m		

GROUP	TYPE	DESCRIPTION	LENGTH	ARTICLE NUMBER			UN.	PRICE / UNIT				
T	RAFTERS		M	O	W 9010	B 8019	RAL	O	W/B			
	T16P	PVC rafter with soft bulbs Not for glass	2		13198	13208		m	-	€ 7.60		
			2.5		13202	13209		m				
			3		13203	13210		m				
			3.5		13204	13211		m				
			4		13205	13212		m				
			5		15588	15587		m				
			6		13206	13213		m				
			7		13207	13214		m				
			T16.1	Alu rafter for 16mm sheets	2	13169				m	€ 6.21	-
					2.5	13170				m		
3	13171						m					
3.5	13172						m					
4	13173						m					
5	14537						m					
6	13174						m					
7	13175						m					
T16.2	Alu rafter for 16mm sheets (self supporting till 80cm)	2	13177	13184	13191		m	€ 7.00	€ 10.38			
		2.5	13178	13185	13192		m					
		3	13179	13186	13193		m					
		3.5	13180	13187	13194		m					
		4	13181	13188	13195		m					
		5	14538	14606	14607		m					
		6	13182	13189	13196		m					
		7	13183	13190	13197		m					
T32.1	Alu rafter for 32mm sheets (self supporting till 100cm)	2	14222	14391	14383		m	€ 7.14	€ 11.06			
		2.5	14223	14392	14384		m					
		3	14224	14393	14385		m					
		3.5	14225	14394	14386		m					
		4	14226	14395	14387		m					
		5	14227	14396	14388		m					
		6	14228	14397	14389		m					
		7	14229	14398	14390		m					
TP	PVC thermal rafter profile for sheets	2.7		21277			m	-	€ 7.95			
		3.2		21278			m					
		3.7		21279			m					
		4.2		21280			m					
		5.2		24468			m					
		6.2		21281			m					

FINISH

O : mill finished aluminium / W : white or RAL 9010 / B : brown or RAL 8019 in stock
RAL colour possibilities for orders of Color-Therm Glass: see p. 9 (price on request). Delivery time: 6 weeks.

GROUP	TYPE	DESCRIPTION	LENGTH	ARTICLE NUMBER			UN.	PRICE / UNIT		
T	RAFTERS		M	0	W 9010	B 8019	RAL	0	W/B	
	TPG	PVC thermal rafter profile for glass	4.2		25055			m	-	€ 7.95
			5.2		25056			m		
			6.2		25057			m		
			7.2		25058			m		
	TPH	Alu support profile for TP - TPG	2.6	22580	22585	22590	24414	m	€ 4.96	€ 7.49
			3.1	22581	22586	22591	24337	m		
			3.6	22582	22587	22592	24415	m		
			4.1	22583	22588	22593	24416	m		
			5.1	25066	25067	25068	25072	m		
			6.1	22584	22589	22594	24417	m		

GROUP	TYPE	DESCRIPTION	LENGTH	ARTICLE NUMBER			UN.	PRICE / UNIT				
L	SIDE RAFTERS		M	0	W 9010	B 8019	RAL	0	W/B			
	LP	PVC side profile with soft bulb for sheets 16, 25 and 32mm Use with CLL and C8	2		17766	17690		m	-	€ 9.36		
			2.5		17767	17759		m				
			3		17768	17760		m				
			3.5		17769	17761		m				
			4		17770	17762		m				
			5		17771	17763		m				
			6		17772	17764		m				
			7		17773	17765		m				
			L16	Alu side profile for 16mm sheets	2	15679				m	€ 6.47	-
					2.5	13221				m		
3	13222						m					
3.5	13223						m					
4	13224						m					
5	14624						m					
6	13225						m					
7	13226				m							
L16P	Alu side finishing profile for 16, 25, 32mm sheets	2.5	16718	15478	15484	21231	m	€ 9.00	€ 10.35			
		3	16719	15479	15485	21232	m					
		3.5	16720	15480	15486	21233	m					
		4	16721	15481	15487	21234	m					
		5	16722	15482	15488	21235	m					
		7	16723	15483	15489	21237	m					
LT16	Alu side profile for 16mm sheets	2	15729	16216	15769		m	€ 8.56	€ 12.84			
		2.5	15490	15534	15541		m					
		3	15491	15535	15542		m					
		3.5	15492	15536	15543		m					
		4	15493	15537	15544		m					
		5	15495	15538	15545		m					
		6	15496	15539	15546		m					
7	15497	15540	15547		m							
L32.1	Alu side profile for sheets >= 25mm	2	15713				m	€ 7.84	€ 12.15			
		2.5	14230				m					
		3	14231				m					
		3.5	14232				m					
		4	14233				m					
		5	14234				m					
		6	14235	14456			m					
7	14238	14457			m							

FINISH

0 : mill finished aluminium / W : white or RAL 9010 / B : brown or RAL 8019 in stock
RAL colour possibilities for orders of Color-Therm Glass: see p. 9 (price on request). Delivery time: 6 weeks.

GROUP	TYPE	DESCRIPTION	LENGTH	ARTICLE NUMBER			UN.	PRICE / UNIT		
L	SIDE RAFTERS		M	O	W 9010	B 8019	RAL	O	W/B	
	LT32	Alu side profile for sheets > 25mm	2	15780	15770	16694		m	€ 10.35	€ 14.10
			2.5	15548	15556	15575		m		
			3	15549	15557	15576		m		
			3.5	15550	15558	15577		m		
			4	15551	15569	15578		m		
			5	15552	15570	15579		m		
			7	15555	15572	15581		m		
	TPGL	PVC thermal side rafter profile for glass	4.2		25059			m	-	€ 7.95
			5.2		25060			m		
			6.2		25061			m		
			7.2		25062			m		
	TPHL	Alu side support for TPGL	4.1	24992	25004	24996	25008	m	€ 4.96	€ 7.49
			5.1	24993	25005	24997	25009	m		
			6.1	24994	25006	24998	25010	m		
			7.1	24995	25007	24999	25011	m		









GROUP	TYPE	DESCRIPTION	LENGTH	ARTICLE NUMBER			UN.	PRICE / UNIT		
Y	RISING PROFILES		M	O	W 9010	B 8019	RAL	O	W/B	
	Y10	Alu adapter profile for 10mm sheets. Slides in the profiles in place of rubber C3 of C8	6.5	18324	18403	18402	21283	m	€ 2.39	€ 4.31
	Y25	Alu adapter profile for 25mm sheets	7	13313				m	€ 2.78	-
	Y32	Alu adapter profile for 32mm sheets	7	13314				m	€ 3.74	-

2. Rubbers and clip profiles

GROUP	TYPE	DESCRIPTION	LENGTH	ARTICLE NUMBER		UN.	PRICE / UNIT	
C	RUBBERS		M	WHITE	GREY			
	C1CX	Coex rubber anti-elastic for CLM	35	17701	17703		m	€ 3.60
	C2CX	Coex rubber anti-elastic for profiles T16P - T16.1 - T16.2 - T32.1 - TP - TPG - TPGL - Y25 - Y32 - LT16 - LT32	2 x 24	18316	18315		m	€ 4.70
			35	15471	17697		m	
			50	15472	17698		m	
	C4CX	Coex rubber anti-elastic for wall profile M16 - M32T and side profile L16 - L32.1	2 x 18	18361	18318		m	€ 4.32
			35	15473	17699		m	
			75	15475	17700		m	
	C12	Support thread for C1CX	200		23875		m	€ 0.60
	C3	Supporting rubber for sheets for T16.1 - T16.2 - T32.1 - L16 - L32.1 - LT16 - LT32	200		13319		m	€ 0.84
	C13	Supporting rubber for glass	200		24328		m	€ 3.69
	C6	Sealing rubber between wooden frame at gutter side and sheets or glass	150		13326		m	€ 4.20
	C8	Sealing rubber for alu clips CL16/32, CLL, CLSB	300		13328		m	€ 1.13
	CY10	Rubber adapter for alu clips CL16 / CL32 / CLL / CLSB / T32.1 / L16 / LT16 / L32 / LT32	50		29509		m	€ 3.19
C11CX	Sealing rubber white-black for gutter G Use with Y16P	50	21557			m	€ 7.18	
C31	Supporting rubber for glass with MP and TPHL	200		28805		m	€ 3.69	



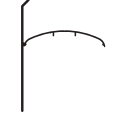







FINISH

O : mill finished aluminium / W : white or RAL 9010 / B : brown or RAL 8019 in stock
RAL colour possibilities for orders of Color-Therm Glass: see p. 9 (price on request). Delivery time: 6 weeks.

GROUP	TYPE	DESCRIPTION	LENGTH	ARTICLE NUMBER					UN.	PRICE / UNIT	
CL	CLIP PROFILES		M	O	W 9010	B 8019	A 7016 ST	RAL		O	W/B/A
	CLM	Alu clips profile for wall profile with 16, 25 and 32mm sheets For use with MP, C1CX and C12	3.5	17707	17724	17721	54973	24375	m	€ 12.48	€ 14.35
			5	17710	17725	17722	54974	24376	m		
			7	17711	17726	17723	54975	24378	m		
	CLL	Alu clip profile for side finish with 16, 25 en 32mm sheets Use with LP, TP, TPGL and rubber C8 or CY10	2	17713	17740	17732	31354	21174	m	€ 15.73	€ 18.08
			2.5	17714	17741	17733	31355	21175	m		
			3	17715	17742	17734	31356	21176	m		
			3.5	17716	17743	17735	31357	21177	m		
			4	17717	17744	17736	31358	21178	m		
			5	17718	17745	17737	31359	21179	m		
			6	17712	17728	17738	31360	21180	m		
7	17719	17746	17739	31361	21181	m					
	CL16	Alu clip profile, use with C8 or CY10 on T16P - TP - TPG In combination with 16mm sheets	2	13329	13336	13343	31234	16063	m	€ 8.88	€ 10.22
			2.5	13330	13337	13344	31235	16064	m		
			3	13331	13338	13345	31236	16065	m		
			3.5	13332	13339	13346	31237	16066	m		
			4	13333	13340	13347	31238	16067	m		
			5	13824	13928	13927	31239	16070	m		
			6	13334	13341	13348	31240	16071	m		
7	13335	13342	13349	31241	16072	m					
	CL32	Alu clip profile, use with C8 or CY10 on T16P - TP - TPG In combination with 25 and 32mm sheets	2	13350	13352	13354	31242	16073	m	€ 11.30	€ 12.99
			2.5	13351	13353	13355	31243	16074	m		
			3	13154	13159	13164	31244	16075	m		
			3.5	13155	13160	13165	31245	16076	m		
			4	13156	13161	13166	31246	16088	m		
			5	14372	14373	14374	31247	16089	m		
			6	13157	13162	13167	31248	16091	m		
7	13158	13163	13168	31249	16092	m					
	CLPV	PVC shockproof clip with soft sealing borders for T16P - T16.1 - T16.2 - T32.1 - TP - TPG - Y25 - Y32 - LT16 - LT32 length = standard length + 25mm	2		15607				m	-	€ 3.58
			2.5		15608				m		
			3		15636				m		
			3.5		15611				m		
			4		15613				m		
			5		15614				m		
			6		15615				m		
7		15616				m					
	CLSB	Screwable clip profile bottom, use with CLST - CLSL and C8 - CY10	4	23914					m	€ 6.34	-
			5	23915					m		
			6	23916					m		
			7	23917					m		
	CLST	Screwable clip profile top, use with CLSB	4	23922	23938	24315	31251	23946	m	€ 4.52	€ 5.17
			5	23923	23939	24316	31252	23947	m		
			6	23924	23940	24317	31253	23948	m		
			7	23925	23941	24318	31254	23949	m		
	CLSL	Screwable side clip profile, use with CLSB	4	25012	25024	25016	31286	25028	m	€ 14.30	€ 16.43
			5	25013	25025	25017	31287	25029	m		
			6	25014	25026	25018	31288	25030	m		
			7	25015	25027	25019	31289	25031	m		
	GVT	Top profile for glass connector	7	27229	27232	27230	31080	27233	m	€ 4.64	€ 6.79
	GVB	Bottom profile for glass connector	7	27252	27255	27253	31162	27256	m	€ 5.10	€ 7.93

FINISH O : mill finished aluminium / W : white or RAL 9010 / B : brown or RAL 8019 / A : anthracite or RAL 7016 ST in stock
RAL colour possibilities for orders of Color-Therm Glass: see p. 9 (price on request). Delivery time: 6 weeks.

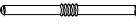
3A. Aluminium gutters

GROUP	TYPE	DESCRIPTION	LENGTH	ARTICLE NUMBER					UN.	PRICE / UNIT		
				M	O	W 9010	B 8019	A 7016ST		RAL	O	W/B/A
	G120A	Alu gutter G120A	3.5	13283	13294	13297	54976	21160	m	€ 20.85	€ 23.99	
			5	13285	13295	13298	54977	21161	m			
			7	13291	13296	13299	54978	21162	m			
		G120AS	End piece gutter for G120A	pc	21310	13306	13307	47198	21588	pc	€ 2.99	€ 3.14
				GR	Raised profile for gutter G120A or G	3.5	17820	17828	17825	31343	21163	m
	5	17819	17830			17826	31344	21164	m			
	7	17821	17831			17827	31345	21165	m			
		GRS1	End piece gutter for GR or G120A	pc	17832	17835	17834		21598	pc	€ 7.29	€ 8.37
				GV	Set for mechanical gutter connection G120A (2 pcs G120AS, 1 pc GB and 10 stainless screws)	pc	17955				pc	€ 8.00
		G	Alu gutter profile G for Color-Therm Glass	3.5	21385	21391	24320	31214	21394	m	€ 37.78	€ 43.44
4.25				23388	23391	25270	31215	23390	m			
5				21386	21392	24321	31216	21395	m			
7				21387	21393	24322	31217	21396	m			
	GAS1	End piece gutter for G + GD	pc	21543	21540	24323	31259	21544	pc	€ 10.60	€ 12.18	
				GRS2	End piece gutter for G + GR	pc	21584	21586	24324	31261	21587	pc
LOGO	Logo for end piece gutter GAS1 and GRS2	pc				29943				pc	€ 3.29	
	BUGS	Universal outlet	pc	22387	22389	22394	31384	22391	pc	€ 10.70	€ 16.98	
			WUGS	Outlet gutter spout	pc	22392				pc	€ 11.20	
	GI	Connecting piece for gutter G			0.3	27732				pc	€ 8.19	
			9091	Connecting plate for gutter G (50 x 13 x 2.5mm)	pc	12368				pc	€ 2.31	
	909	Connecting pins for G or raised profile GR	pc	8434					pc	€ 0.75		
			Y16P	Thermal break in ABS 16mm black for rubber C11CX with gutter G	1	21528				m	€ 3.45	
4	21529						m	€ 3.45				
	GC	PVC water outlet + swivel Ø 80 (grey or brown)	pc		13308	13450			pc		€ 6.32	
			GB	Sealing tape gutter connector 350 x 225mm	pc	13309				pc	€ 2.18	
	411	Outlet 3m + socket 5 years colour guarantee	3		10523	10524			m		€ 9.01	
	412	Bracket for outlet	pc		10526	10527			pc		€ 2.65	
	412S	Screw for bracket	pc	10532					pc	€ 0.42		
	413	Elbow 67° 30 with socket Ø 80mm	pc		10528	10529			pc		€ 6.36	
	414	Elbow 87° with socket Ø 80mm	pc		10530	10531			pc		€ 6.36	
	BR	T-connecting piece 67°-30 Ø 80mm	pc		15180	15181			pc		€ 9.54	

3B. Polyester gutters Evaco®

See price list roof edge trims and gutters

FINISH

O : mill finished aluminium / W : white or RAL 9010 / B : brown or RAL 8019 / A : anthracite or RAL 7016 ST in stock RAL colour possibilities for orders of Color-Therm Glass: see p. 9 (price on request). Delivery time: 6 weeks.

4. Ridge profiles

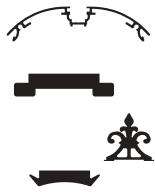

GROUP	TYPE	DESCRIPTION	LENGTH	ARTICLE NUMBER					UN.	PRICE / UNIT	
				M	O	W 9010	B 8019	RAL		O	W/B
	841	Ridge profile Combine with 844, C4CX (2 x), C9 and C10	7.6	17559	17566		17588	m	€ 24.75	€ 42.97	
	844	Cover profile ridge (anodised aluminium)	6.5	16793				pc	€ 31.68		
	847	Lily ridge	pc	16803	16805		16807	pc	€ 37.04	€ 64.09	
	C9	Rubber for ridge profile 841 (black)	50	16795				m	€ 2.46		
	C10	Rubber flashing 200mm (black)	25	18747				m	€ 4.18		
	846	End piece for ridge profile	pc	16799	16800		16802	pc	€ 25.62	€ 29.46	

5A. Finishing profiles

GROUP	TYPE	DESCRIPTION	LENGTH	ARTICLE NUMBER					UN.	PRICE / UNIT	
				M	O	W 9010	B 8019	A 7016 ST		RAL	O
	U16P	reinforced PVC end profile for sheets 16mm	0.98		13383				pc	€ 3.66	
			1.053		13384				pc	€ 3.92	
			1.2		13385				pc	€ 4.46	
			1.25		13386				pc	€ 4.67	
			6.4		13396				pc	€ 23.84	
	U25P	reinforced PVC end profile for sheets 25mm	1.2		13397				pc	€ 5.59	
			2.1		35375				pc	€ 9.78	
			5		13441				pc	€ 23.27	
	U32P	reinforced PVC end profile for sheets 32mm	0.98		17874				pc	€ 5.22	
			1.053		27249				pc	€ 5.61	
			1.23		13400				pc	€ 6.40	
			1.25		13401				pc	€ 6.53	
			5		13440				pc	€ 26.05	
	U16A	Alu end profile for sheets 16mm	0.98	13406		13413*		17210	pc	€ 4.07	€ 5.96
			1.053	13407		13414*		17211	pc	€ 4.40	€ 6.42
1.2			13408		13415*		17212	pc	€ 5.00	€ 7.31	
6.5			18321		18322*		23210	pc	€ 27.07	€ 39.61	
U32A	Alu end profile for sheets 32mm	1.23	13469				15917	pc	€ 7.31		
U16	Pre-drilled alu end profile for sheets 16mm	0.98	23553	23569	23557	31183	23565	pc	€ 7.37	€ 9.77	
		1.053	23554	23570	23558	31184	23566	pc	€ 7.37	€ 9.77	
		1.2	23555	23571	23559	31185	23567	pc	€ 8.88	€ 11.67	
		6.1	23556	23572	23560	31186	23568	pc	€ 49.25	€ 64.73	
		0.98	27239	27245	27237	31396	27243	pc	€ 9.33	€ 12.03	
		1.23	21534	21552	21546	31195	21555	pc	€ 11.42	€ 14.72	
U32	Pre-drilled alu end profile for sheets 32mm	5	21535	21553	21547	31196	21556	pc	€ 46.43	€ 59.85	
		L432	L 40/30/2 alu finishing profile for glass 8-34mm thickness	6	23529	23552	24336	31160	23551	m	€ 6.06

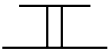

* while stock lasts

FINISH	O : mill finished aluminium / W : white or RAL 9010 / B : brown or RAL 8019 / A : anthracite or RAL 7016 ST in stock RAL colour possibilities for orders of Color-Therm Glass: see p. 9 (price on request). Delivery time: 6 weeks.
--------	--

GROUP	TYPE	DESCRIPTION	LENGTH	THICKN.	ARTICLE NUMBER	UN.	PRICE/UN.
U - H	POLYCARBONATE PROFILES		M	MM			
	UPH	Transparent polycarbonate connecting profile for vertical sheets (6-10-16mm)	6	6	13435	pc	€ 31.47
				10	13418	pc	€ 36.89
				16	13434	pc	€ 55.32
	UPU	Transparent polycarbonate end profile for 6-10-16mm sheets Not for outdoor use	2.1	6	13438	pc	€ 2.90
				10	13436	pc	€ 4.41
				16	13437	pc	€ 6.24
	UA16	Filling profile for Alltop sheets with sawn borders	3.5	16	12671	pc	€ 27.03

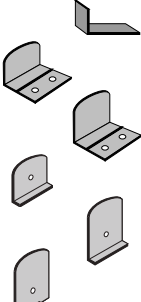

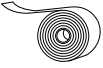
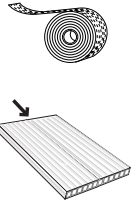
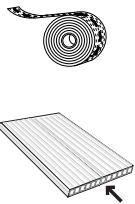
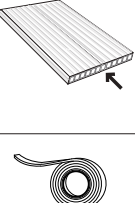

5B. Accessories

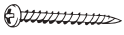

GROUP	TYPE	DESCRIPTION	QUANT.	ARTICLE NUMBER					UN.	PRICE/UNIT	
S	STOP		0	W	B	A	RAL		0	W/B/A	
	S16	Stop for alu profiles	pc	49743	13530	13217			pc	€ 1.34	€ 3.14
	S16C	Stop for alu profiles with 16mm sheets	pc	15582	15583	15709			pc	€ 2.32	€ 4.10
	S32C	Stop for alu profiles with 25 and 32mm sheets	pc	15584	15585	15711			pc	€ 2.50	€ 4.48
	S16.3	Stop 3mm for T16P, TP and LP with 16mm sheets	pc	21218	21562	21560	31255	21563	pc	€ 2.42	€ 3.93
	S32.3	Stop 3mm for T16P, TP and LP with 25/32mm sheets	pc	21220	21566	21564	31256	21567	pc	€ 2.53	€ 4.20
	S38.3	Stop 3mm for TPG and TPGL with glass	pc	25079	25082	25080	31257	25083	pc	€ 3.85	€ 4.42

GROUP	TYPE	DESCRIPTION	QUANTITY	ARTICLE NUMBER	UN.	PRICE/UNIT
B	TAPES		ROLL LENGTH (M)			
	BTA	Anti-dust alu tape	50	13369	pc	€ 17.06
	BT16	Closed synthetic tape for 10 and 16mm sheets With guarantee	10	14408	pc	€ 7.47
			50	14409	pc	€ 21.56
			10	14411	pc	€ 8.51
			50	14412	pc	€ 25.05
	BT32	Closed synthetic tape for 32mm sheets With guarantee	10	14413	pc	€ 10.25
			50	14415	pc	€ 30.26
			10	13372	pc	€ 13.93
			33	13373	pc	€ 33.40
	BB25	Perforated synthetic tape for 25mm sheets With guarantee	10	14416	pc	€ 18.45
			33	14424	pc	€ 43.50
			10	13374	pc	€ 24.00
			33	13376	pc	€ 57.40
	BM	One-sided adhesive tape 15 x 8mm for sealing between sheets and wall profile M16 / M32B	6	13377	pc	€ 4.18

FINISH

0 : mill finished aluminium / W : white or RAL 9010 / B : brown or RAL 8019 / A : anthracite or RAL 7016 ST in stock
RAL colour possibilities for orders of Color-Therm Glass: see p. 9 (price on request). Delivery time: 6 weeks.

GROUP	TYPE	DESCRIPTION	QUANT.	ARTICLE NUMBER				UN.	PRICE/UNIT	
MT	MOUNTING ACCESSORIES		0	W 9010	B 8019	A 7016 ST	RAL	0	W/B/A	
	HILO25	Galvanised hilo screw for PVC 5.2 x 25mm for CLSB (set of 25 pcs)	25 pcs	24202				set (25)	€ 5.00	
	HILO42	Galvanised hilo screw for PVC 5.2 x 42mm for CLSB (set of 25 pcs)	25 pcs	24201				set (25)	€ 5.00	
	ZSC	Stainless steel screw 5.5 x 32 + butyl sealing TX 25 self drilling for TP - TPG	pc	23963				pc	€ 0.88	
	ZSB/G	Stainless steel screw 5.5 x 32 TX 25 self drilling for TP - TPG	pc	20911	18740	18742	31382	21596	pc	€ 0.39 € 0.51
	PS48	Self drilling stainless parker screw 4.8 x 25mm for stop	pc	8431	22595	22597	31383	22598	pc	€ 0.07 € 0.31
	BITS	Torxbit TX25 for stainless steel screw	pc	18744				pc	€ 2.14	
	GATZ	Core drill Ø 80mm	pc	41354				pc	€ 24.18	
	GSP 8	PVC buffer for single glazing	pc	27578				pc	€ 0.21	
	GSP 20	PVC buffer for double glazing	pc	27331				pc	€ 0.34	

GROUP	TYPE	DESCRIPTION	QUANT.	ARTICLE NUMBER				UN.	PRICE/UNIT	
MISCELLANEOUS			0	W 9010	B 8019	A 7016 ST	RAL	0/W/B/A	RAL	
	LAK	Paint brush for repair	pc		24198	33740	31385	24199	pc	€ 8.72 € 17.46
	SILI	Silicone 310ml for use with PMMA and PC warranty 10 years with certificate mill finished & RAL = transparant	pc	15460 (transp)	4736			15460 (transp)	pc	€ 8.64 € 8.64
	SG20	Silicone glue 310ml for glass connector GVB and GVT (grey)	pc	27494 (grey)					pc	€ 29.18

FINISH

0 : mill finished aluminium / W : white or RAL 9010 / B : brown or RAL 8019 / A : anthracite or RAL 7016 ST in stock
RAL colour possibilities for orders of Color-Therm Glass: see p. 9 (price on request). Delivery time: 6 weeks.

6. Prepacked profiles with PE film

One packing contains: 1 profile + stop profile + matching rubber or clip + label with description and bar code.

GROUP	TYPE	DESCRIPTION	LENGTH	ARTICLE NUMBER			UN.	PRICE/M		PRICE STOP											
				0	W 9010	B 8019		0	W/B												
E	PREPACKED PROFILES	M	0	W 9010	B 8019			0	W/B	stop + screw											
												EM16	M16 + C4CX Set of wall profiles for series ALU / COLOR	3.5	13429	15887	15745	pc	€ 17.19 /m	€ 18.89 /m	-
														5	13431	15741	15696	pc			
														7	13432	15840	15714	pc			
												EM32	M32T + M32B + C4CX Set of wall profiles for series ALU / COLOR	3.5	26655			pc	€ 23.17 /m	-	-
														5	26656			pc			
														7	43972			pc			
												EMP	MP + CLM + C1CX + C12 Set of wall profiles for series THERM / COLOR-THERM / COLOR-THERM GLASS	3.5		18186	17947	pc	-	€ 32.73 /m	-
														5		17943	18119	pc			
														7		17972	18106	pc			
												ET16.1	T16.1 + C2CX (grey) + C3 (2x) + S16C + screw (2x) Set of rafter profiles for series ALU	2	13288			pc	€ 15.10 /m	-	€ 2.95
														2.5	13289			pc			
														3	13300			pc			
														3.5	13302			pc			
														4	13303			pc			
														5	14583			pc			
														6	13304			pc			
											7	13305			pc						
												ET16.2	T16.2 + C2CX + C3 (2x) + S16C + screw (2x) Set of rafter profiles for series ALU / COLOR	2	13263	13807		pc	€ 16.04 /m	-	€ 2.95
														2.5	13278	13796	45960	pc			
														3	13279	13722		pc			
														3.5	13282	14204	13571	pc			
														4	13284	15011		pc			
														5	14684		14794	pc			
														6	13286			pc			
												ET32.1	T32.1 + C2CX + C3 (2x) + S32C + screw (2x) Set of rafter profiles for series ALU / COLOR	2	25717		15930	pc	€ 16.23 /m	-	€ 3.17
														2.5	30993			pc			
3	23577	44834		pc																	
3.5	23578	46379		pc																	
4	23579	43964	26561	pc																	
5	27568	43965	15929	pc																	
6	31640		15928	pc																	
7	42877			pc																	
	ET16P	T16P + CLPV (W) + S16.3 + screw Set of rafter profiles for series THERM	2		15882	17131	pc	-	€ 13.42 /m	€ 5.09											
			2.5		15698	15697	pc														
			3		15731	15782	pc														
			3.5		15795	15845	pc														
			4		15870	15746	pc														
			5		15828	15781	pc														
			6		16942	22465	pc														
7		15829		pc																	
	ETP 16	T16P + CL16 + C8 + C8 + S16.3 + screw Set of rafter profiles for series COLOR-THERM	2		19563	18443	pc	-	€ 24.11 /m	€ 5.09											
			2.5		18408	18165	pc														
			3		18100	18988	pc														
			3.5		18108	18166	pc														
			4		18223	17949	pc														
			5		17971	18411	pc														
			6		18410	18262	pc														
7		18187	18577	pc																	

FINISH

0 : mill finished aluminium / W : white or RAL 9010 / B : brown or RAL 8019

GROUP	TYPE	DESCRIPTION	LENGTH	ARTICLE NUMBER		UN.	PRICE/M		PRICE STOP
				0	B 8019		0	W/B	
	ETP 32	T16P + CL32 + C8 + C8 + S32.3 + screw Set of rafter profiles for series COLOR-THERM	2	18475	19014	pc	-	€ 27.42 /m	€ 5.41
			2.5	18627	18306	pc			
			3	18284	18732	pc			
			3.5	18188	18120	pc			
			4	18027	18333	pc			
			5	17945	18388	pc			
			6	17946	19025	pc			
	7	18107	18189	pc					
	EL16	L16 + C4CX (grey) + C3 + S16C + screw (2x) Set of side rafter profiles for series ALU	2	15826		pc	€ 13.96 /m	-	€ 2.95
			2.5	13375		pc			
			3	13420		pc			
			3.5	13421		pc			
			4	13422		pc			
			4.5	26238		pc			
			5	14629		pc			
	6	13423		pc					
	7	13424		pc					
	EL32	L32.1+ C4CX (grey)+ C3 + S32C + screw (2x) Set of side rafter profiles for series ALU	2	26631		pc	€ 15.61 /m	-	€ 3.17
			2.5	26632		pc			
			3	23580		pc			
			3.5	23581		pc			
			4	23582		pc			
			5	16093		pc			
			6	31641		pc			
	7	35830		pc					
	ELT16	LT16 + C2CX + C3 + S16C + screw (2x) Set of side rafter profiles for series COLOR	2		16215	pc	€ 16.92 /m	-	€ 2.95
			2.5	22805	45961	pc	€ 22.05 /m	€ 5.09	
			3	22806	16696	pc			
3.5			22898	17137	pc				
4			16579	17330	pc				
5			16697	17605	pc				
6	16729		pc						
EL16P	L16P + CLPV (W) + T16P + S16.3 + screw Set of side rafter profiles for series THERM	2.5		15732	15963	pc	-	€ 25.83 /m	€ 5.09
		3		15738	15783	pc			
		3.5		15796	15846	pc			
		4		15871	16240	pc			
		5		15827	16600	pc			
		6		18208	18317	pc			
		7		18209		pc			
ELP 16	LP + CLL + C8 + S16.3 + screw Set of side rafter profiles for series COLOR-THERM	2	18407	18469	pc	-	€ 34.29 /m	€ 5.09	
		2.5	18185	18097	pc				
		3	18103	18178	pc				
		3.5	18109	18098	pc				
		4	18222	17948	pc				
		5	17941	18387	pc				
		6	17942	18263	pc				
7	18442	18578	pc						
ELP 32	LP + CLL + C8 + S32.3 + screw Set of side rafter profiles for series COLOR-THERM	2	23515	25485	pc	-	€ 34.29 /m	€ 5.41	
		2.5	23953	23629	pc				
		3	23621	23631	pc				
		3.5	23545	23041	pc				
		4	23262	22941	pc				
		5	23165	22942	pc				
		6	23026	23027	pc				
7	25552	24658	pc						

Other profiles also available prepacked: price and terms of delivery on request

FINISH	0 : mill finished aluminium / W : white or RAL 9010 / B : brown or RAL 8019
--------	---